

C Series Programmable IO System

User Manual

V1.00

C Series – Programmable IO System



ODOT Automation System Co., Ltd.

2022-04

Copyright ©2020 ODOT Automation all rights reserved

Version information

The following changes have been made to the document:

Date	Version	Modifications	Author
2022-04-20	V1.00	Released Version	DLC/CCL

Ownership rights information

Without the permission of the copyright owner, all or part of this document shall not be republished as a paper or electronic document.

Disclaimer

This document is only intended to assist the reader in using the products, and the company shall not be responsible for any loss or error caused by the use of the information in this document. The product and text described in this document are under constant development and refinement. ODOT Automation System Co., Ltd. has the right to modify this document without notifying users.

Software download

Please log on the official website: www.odotautomation.com and click on the corresponding product page to download.

Content

1 Product Overview 6

 1.1 Model Selection Table 7

2 Module Parameter 9

 2.1 General Parameters 9

 2.2 Interface Parameter 9

 2.3 CP-9131 Modbus Connection Parameters 10

3 Module Description 11

 3.1 CP-9131 Programmable IO 11

 3.2 LED Indicator 12

 3.3 Ethernet Interface 13

 3.4 Wiring Terminal 14

 3.4.1 485 Interface 14

 3.4.2 Power Interface 14

 3.5 Installation 16

 3.6 Wiring 17

 3.7 Dimension 18

4 IO Config Software 19

 4.1 IOConfig Configured Software Installation 19

 4.2 Module Parameter Configuration 20

5 Programmable IO Configured Software (CIACON) 23

 5.1 Programming software Installation 23

 5.2 Applying of CIACON Software 27

 5.2.1 Create New Projects 27

 5.2.2 CIACON Software Interface 28

 5.2.3 Configure I/O module 30

 5.3 Programming 33

5.4 Download and monitor	35
5.5 Master Function	38
5.6 Modbus TCP Slave Function	44
5.7 Modbus RTU Master Function	48
5.8 Modbus RTU Slave Function	53
6 Update the firmware	57

1 Product Overview

CP-9131 is the first version of ODOT Automation PLC, the programming environment follows the IEC61131-3 international standard programmable system, and it supports 5 programming languages such as Instruction List (IL), Ladder Diagram (LD), Structured Text (ST), Function Block Diagram (CFC/FBD) and Sequential Function Chart (SFC).

The PLC could support 32 pcs of IO modules, and its program storage supports 127Kbyte, data storage supports 52Kbyte, the data storage area contains input area of 1K(1024Byte), output area of 1K(1024Byte), and intermediate variable area of 50K. With built-in standard serial communication RS485 interface, it carries with 2 RJ45 interfaces which is a small PLC with rich functions.

CP-9131 is the core component of the whole C series, its main work is not only responsible for executing the user's logic program, but also responsible for all I/O data receiving and sending, communication data processing and other works. With rich instructions, reliable function, good adaptability, compact structure, easy to expand, cost-effective, strong versatility, programming, monitoring, debugging, field operation are very convenient, the PLC could be applied to a variety of automation systems.

The Ethernet interface on the CPU supports the Modbus TCP Server function, supports the third-party Modbus TCP Client to access data, supports Modbus TCP Client function, supports to access to data of third-party Modbus TCP Server.

The RS485 port supports the Modbus RTU master, Modbus RTU slave, and supports third-party devices to communicate with PLC through a serial port.

1.1 Model Selection Table

No.	Model	Function Description	Status
1	CP-9131	Programmable Controller	Released
2	CN-8011	Modbus-RTU Network adapter	Released
3	CN-8012	Profibus-DP Network adapter	Released
4	CN-8013	CC-Link Network adapter	Released
5	CN-8021	CANopen Network adapter	Released
6	CN-8031	Modbus TCP Network adapter	Released
7	CN-8032	Profinet Network adapter	Released
8	CN-8033	EtherCAT Network adapter	Released
9	CN-8034	EtherNET/IP Network adapter	Released
9	CT-1218	8 Channels Digital Input, PNP/24V valid, sink type	Released
10	CT-121F	16 Channels Digital Input, PNP/24V valid, sink type	Released
11	CT-122F	16 Channels Digital Input, NPN/0V valid, source type	Released
12	CT-124H	32 Channels Digital Input, PNP/24V valid, sink type; NPN/0V valid, source type	Released
13	CT-2224	4 Channels Digital Output, 2A/PNP/24V valid, source type	Released
14	CT-2228	8 Channels Digital Output, 0.5A/PNP/24V valid, source type	Released
15	CT-222F	16 Channels Digital Output, 0.5A/PNP/24V valid, source type	Released
16	CT-222H	32 Channels Digital Output, 0.5A/PNP/24V valid, source type	Released
17	CT-221F	16 Channels Digital Output, 0.5A/NPN/0V valid, sink type	Released
18	CT-2718	8 Channels Relay Output, 2A/30VDC/60W	Released
19	CT-3158	8 Channels Voltage Input 0~5VDC/0~10VDC/±5VDC/±10VDC,12-bit	Released
20	CT-3168	8 Channels Voltage Input 0~5VDC/0~10VDC/±5VDC/±10VDC,15-bit	Released
21	CT-3238	8 Channels analog input/ 0& 4-20mA/15-bit, single ended	Released

22	CT-3268	8 Channels analog input, 0~20mA /-20~0mA /±20mA , 15-bit, Single-ended bipolar	Released
23	CT-3713	3 Channels Analog Input, RTD-PT100	Released
24	CT-3804	4 Channels Thermocouple Input, TC-J / K / E / T / S / R / B / N / C type	Released
25	CT-3808	8 Channels Thermocouple Input, TC-J / K / E / T / S / R / B / N / C type	Released
26	CT-4154	4 Channels Voltage Output 0~5VDC/0~10VDC/±5VDC/±10VDC,16-bit	Released
27	CT-4158	8 Channels Voltage Output 0~5VDC/0~10VDC/±5VDC/±10VDC,16-bit	Released
28	CT-4234	4 Channels Analog Output 0&4-20mA/16-bit, Single-ended	Released
29	CT-5102	2 Channels Encoder input, 5VDC	Released
30	CT-5112	2 Channels Encoder input, 24VDC	Released
31	CT-5122	2 Channels Encoder, SSI input	Released
32	CT-5142	2 Channels Encoder, differential input	Released
33	CT-5321	1 channel serial port module, Modbus master / Modbus slave / free port mode	Released
34	CT-5710	Fieldbus Extended Master Module	Released
35	CT-5720	Fieldbus Extended Slave Module	Released
36	CT-5800	Terminal module	Released
37	CT-5801	Terminal module as extra module, take no module channel	Released
38	CT-623F	8 channels digital input, PNP/ 24V valid/sink type; NPN/ 0V valid/source type &8 channels digital output, 0.5A/PNP/24V Valid/ source type,	Released
39	CT-7221	Expansion power Supply 5V/2A	Released

2 Module Parameter

2.1 General Parameters

General Parameters	
System Power	Power supply: 9-36Vdc (Nominal:24Vdc) Protection: overcurrent protection, anti-reverse connection protection
Power Consumption	50mA@24Vdc
Internal bus power supply current	Max: 2.5A@5VDC
Isolation	System Power to Field Power: Isolation
Field Power	Range: 22-28Vdc (Nominal:24Vdc)
Field Power Current	Max.DC 8A
IO Modules Supported	32 pcs
Wiring	Max.1.5mm (AWG 16)
Mounting Type	35mm DIN-Rail
Size	115*51.5*75mm
Weight	130g
Environment Specification	
Operation Temperature	-40~85°C
Operation Humidity	5%-95% (No Condensation)
Protection Class	IP20

2.2 Interface Parameter

Programming Specification	
Programming Software	CIACON
Program Storage	127KBytes
Data Storage Unit	52KByte
Run-Time System	Multiple PLC Task
Programming Language	IEC 61131-3 (LD, IL, ST, FBD, SFC)
RTC	Supported
Max. Task	3
Max. Cyclic Task	3
Max. State Task	3
Scanning Time	1ms
Interface Parameters	
Max. Extension Module	32
Max. Input Size	512 Word (1024Byte)
Max. Output Size	512 Word (1024Byte)
Max. Nodes Number	Restricted by the Ethernet specification

Baud Rate	10/100Mbps, Self-adaptive, full duplex
Network Protocol	Modbus TCP、 Modbus RTU
serial Port Configuration (RS485)	Modbus RTU, Baud Rate: 2400~115200bps
LED Indicator	6 pcs of LED Indicator PWR STAT RUN ERR IRN IER

2.3 CP-9131 Modbus Connection Parameters

Function	Max. number of communication connections
Modbus TCP Master (Client)	Supports connection of 5 Modbus TCP servers
Modbus TCP Slave (Server)	Supports simultaneous connection of 5 Modbus TCP clients
Modbus RTU Master	Supports the connection of 5 slave devices
Modbus RTU Slave	Supports the connection of 1 master device

3 Module Description

3.1 CP-9131 Programmable IO

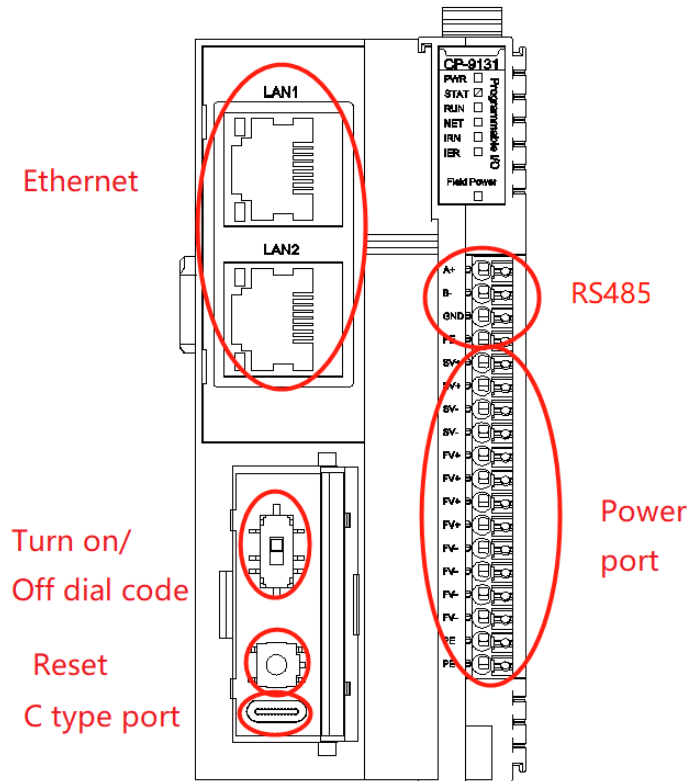

3.2 LED Indicator

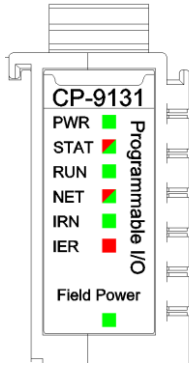

PWR power state (GREEN)	Definition
ON	System Power Normal
OFF	System Power Failure
STAT module state (RED/GREEN)	Definition
Double Flash (RED)	Module Soft Restarted by Hard-Fault
ON(GREEN)	Running
Single Flash (GREEN)	Stopping
Flash(2.5Hz) (RED/GREEN)	Boot Mode
Flash(10Hz) (RED/GREEN)	Firmware Updating
RUN network state (GREEN)	Definition
ON	The PLC is running
OFF	The PLC is not running
NET network state (RED/GREEN)	Definition
ON(GREEN)	The configuration of the current module is consistent with PLC
Flash(RED)	The configuration of the current module is inconsistent with PLC
OFF	NO ERROR
IRN io run (GREEN)	Definition
ON	IO initialization normal
OFF	IO initialization failure
IER io error (RED)	Definition
Definition	IO communication normal
Double Flash	IO communication failure
Field Power field power state (GREEN)	Definition
ON	Field Power Normal
OFF	Field Power Failure

3.3 Ethernet Interface

LAN1/LAN2 supports the switch cascading function, adaptive rate of 10Mbps/100Mbps.

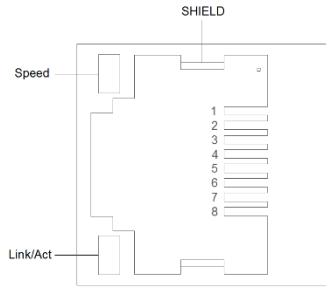

Speed: Network Speed (Green)

ON: 100Mbps

OFF:10Mbps

Link/Act: Link State, Active State (Orange)

ON: Link UP

OFF: Link DOWN

Flash: Active

SHIELD: RJ45 Shield Interface

RJ45 Pin definition

Pin	Pin	Description
1	TD+	Transmitter Data +
2	TD-	Transmitter Data -
3	RD+	Receiver Signal +
4	--	--
5	--	--
6	RD-	Receiver Signal -
7	--	--
8	--	--

3.4 Wiring Terminal

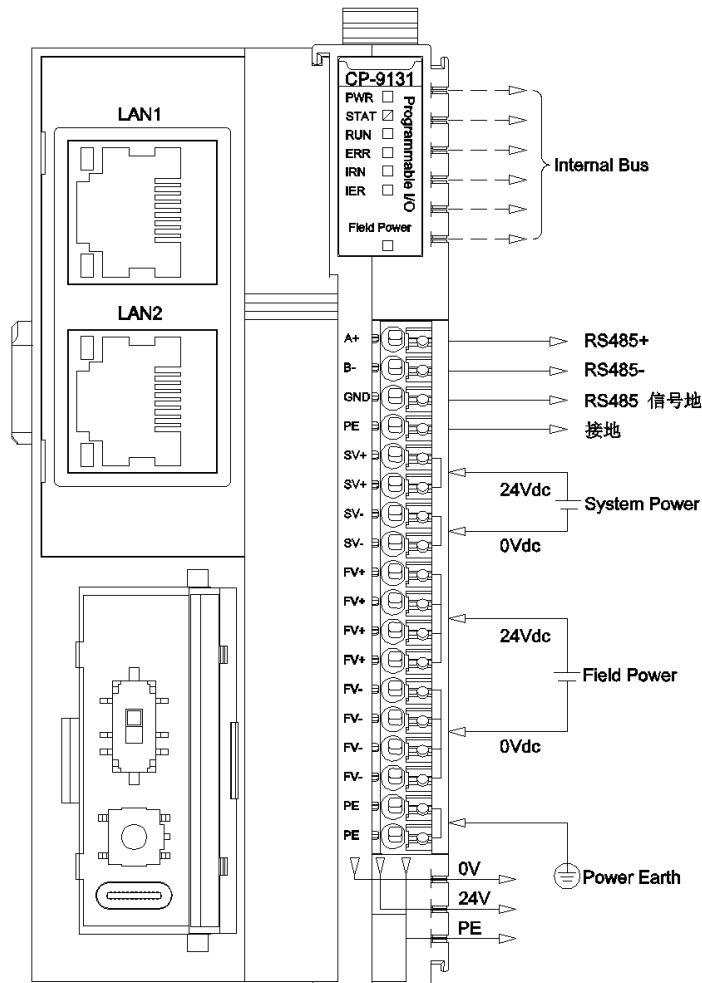

3.4.1 485 Interface

The RS485 wiring terminal adopts the top 4 pins of the wiring terminal, which are defined as follows:

Pin	Definition	Description
1	A+	RS485 A+
2	B-	RS485 B-
3	SGND	Signal Grounded
4	PE	Protect Earthing

3.4.2 Power Interface

Power supply wiring terminals adopt wiring terminals of 5-18 pin, and pins are

defined as follows:

Pin	Definition	Description
1	A+	RS485 A+
2	B-	RS485 B-
3	SGND	Signal Grounded
4	PE	Protect Earthing
5	SV+	System Power 24Vdc
6	SV+	
7	SV-	System Power 0Vdc
8	SV-	
9	FV+	Field Power 24Vdc
10	FV+	
11	FV+	
12	FV+	
13	FV-	Field Power 0Vdc
14	FV-	
15	FV-	
16	FV-	
17	PE	Protect Earthing
18	PE	

It is recommended to use cables with cores smaller than 1mm ?

The cold-pressed terminal parameters are as follows:

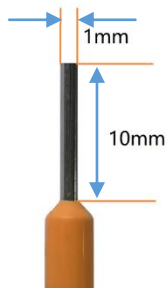

3.5 Installation

DIN rail locks could be installed safely and reliably on 35 mm DIN rail.

When removing a module, it is required to unlock the upper rail lock of the module, and it also needs to clockwise open the left rail lock of the adapter module.



When installing a module, there is a manual latch on the upper side of all modules, which needs to be pressed to hear a "clops".

And there is a manual latch on the left side of the adapter, which needs to be pressed counterclockwise to lock the Din rail.



3.6 Wiring

It uses push-in connection to connect single wire or crimp terminal (ferrule) wire, and there is no need for any other tools.

The users could save the wiring time, and regardless of wiring experience it could ensure safe connection.



The cable harness is for fixing cables when the I/O module is wired to multiple cables.

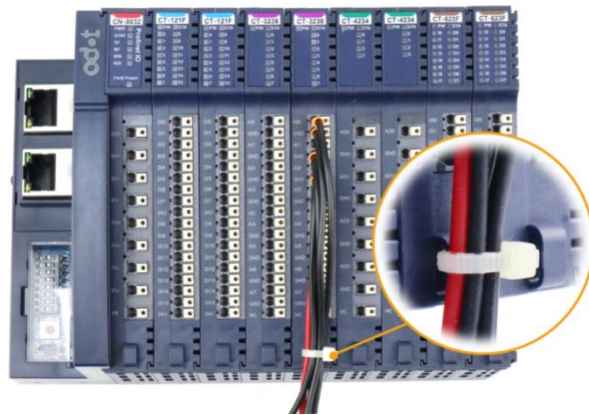

3.7 Dimension

CP-9131 Module installation size: 115*51.5*75mm

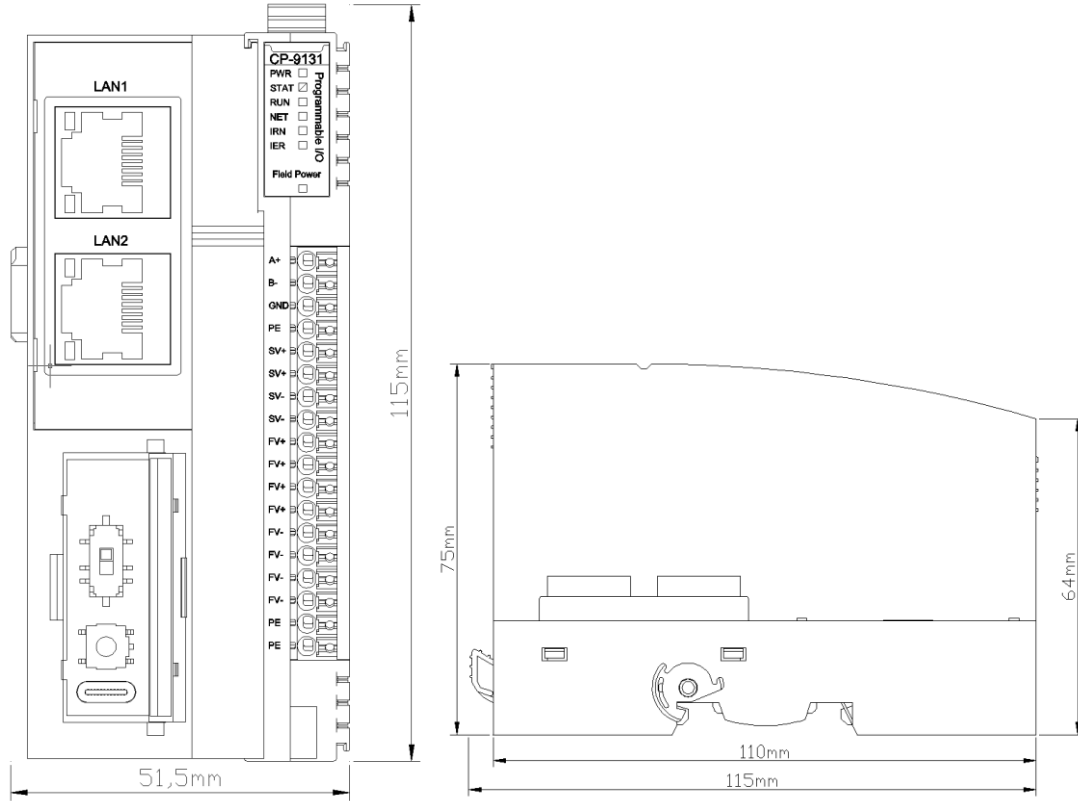

4 IO Config Software

IOConfig is compatible with CP-9131. So it could use IOConfig the configured software to set I/O module parameters.

4.1 IOConfig Configured Software Installation

ODOT Automation provides the IOConfig configured software installation package to the users. The customer could double-click the installation package and click OK → Next → Install → Finish to complete the configured software installation.

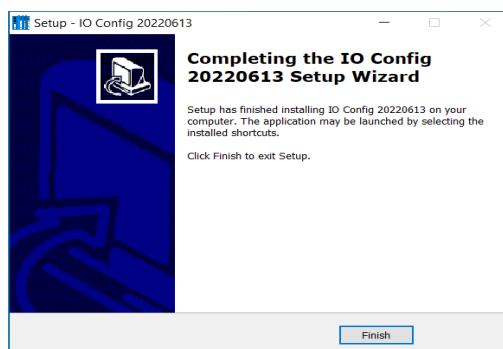
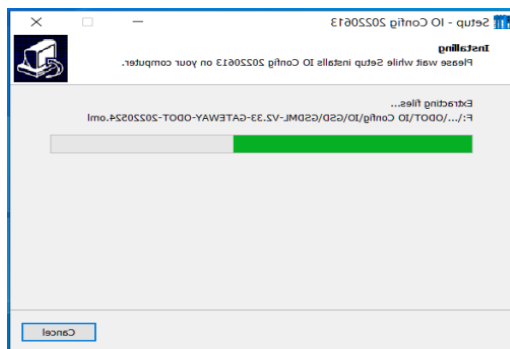
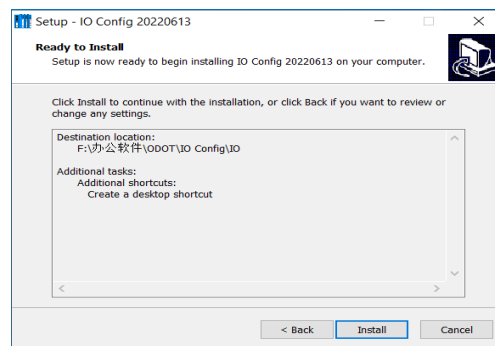
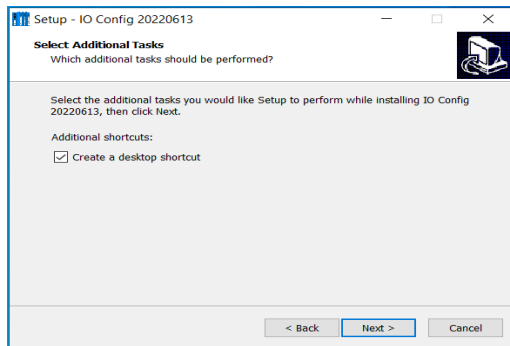
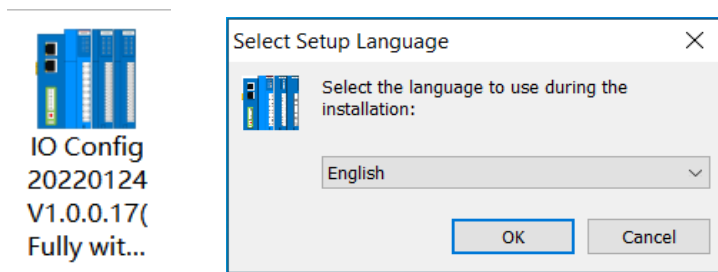

4.2 Module Parameter Configuration

Double-click the IOConfig shortcut icon to open the configured software, and click the search shortcut icon.

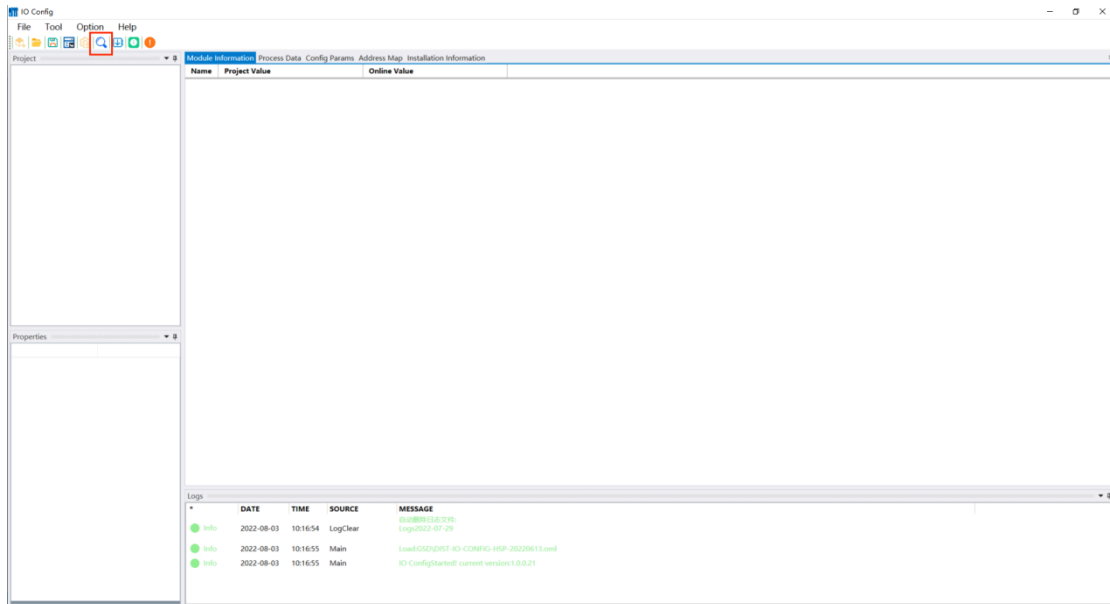

Select the local network card, and click Search device, CP-9131 module can be displayed in the device list, click Upload.

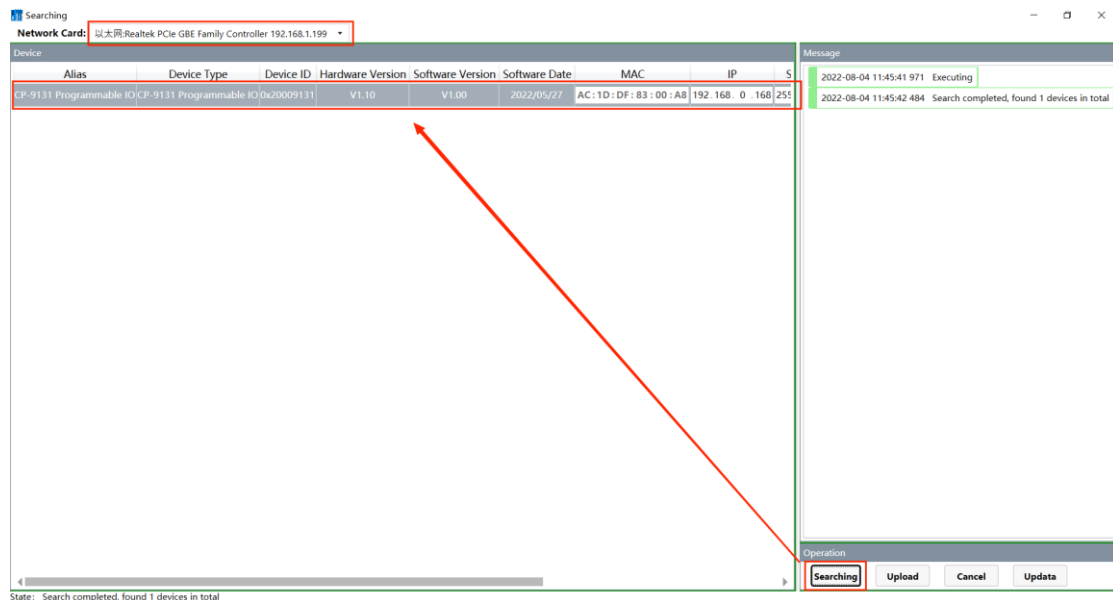

Alternatively, create a project on the initial interface, and select Ethernet as the upload interface, and enter the following IP address:

192.168.0.168

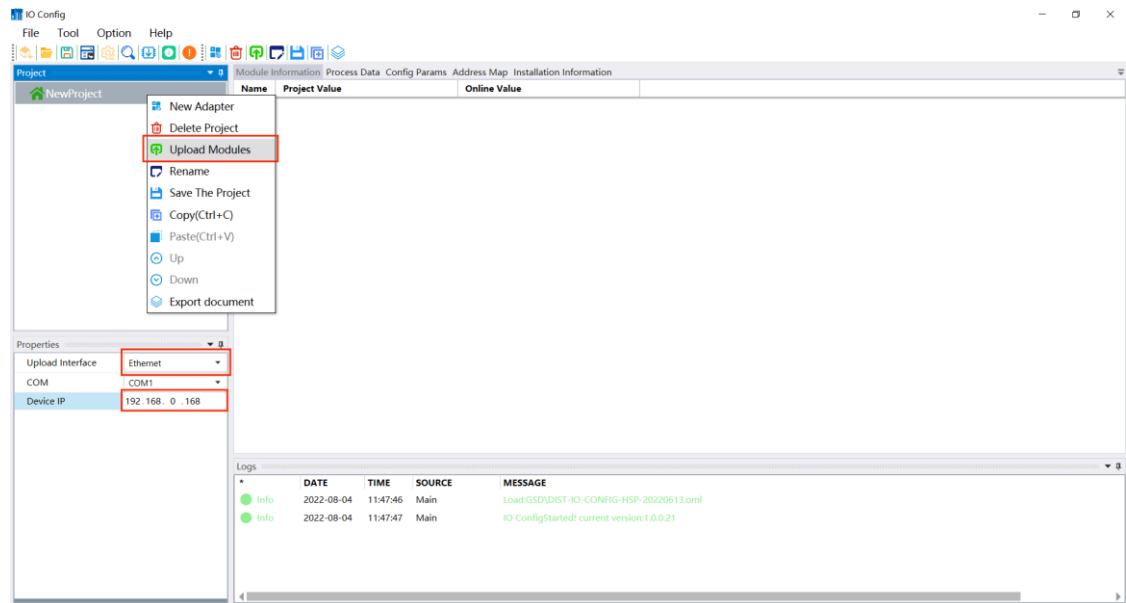
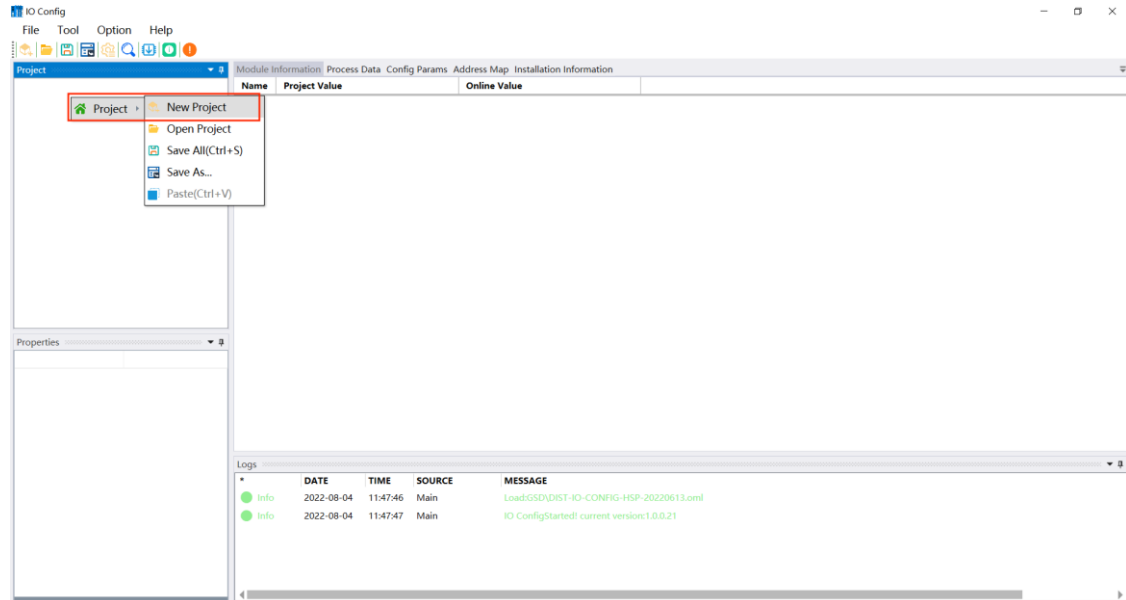

Select the IO module CT-3158, the default parameter voltage type is 0-10V, and the filtering time is 10ms. The channel voltage type can be changed to other ranges according to the actual application requirements of customers, and the filtering time can be increased. The corresponding parameters of other modules can also be modified. After the modification, please right-click CP-9131 and click Download configuration.

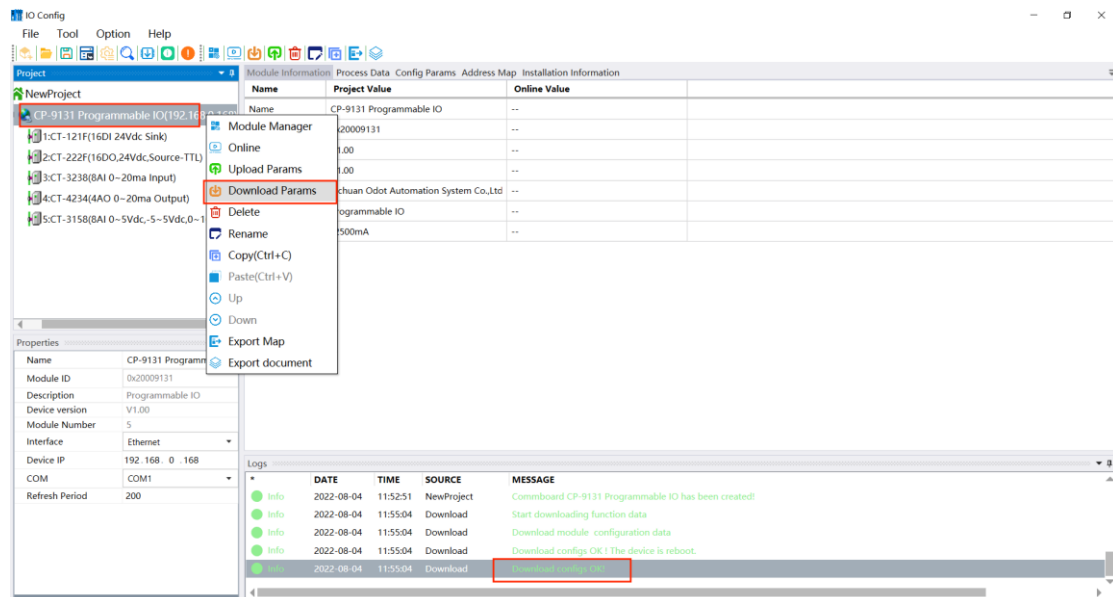
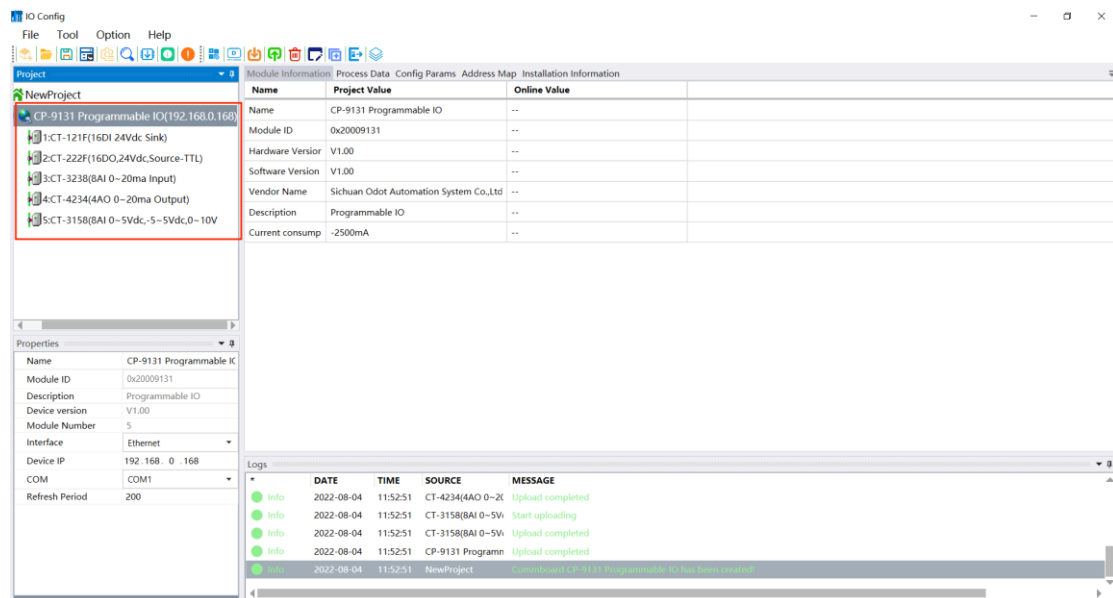

After the I/O module is configured, the I/O modules could function normally.

5 Programmable IO Configured Software (CIACON)

5.1 Programming software Installation

Double-click the installation package of the programming software to install it.

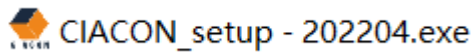

Click I agree to this agreement and click Next.

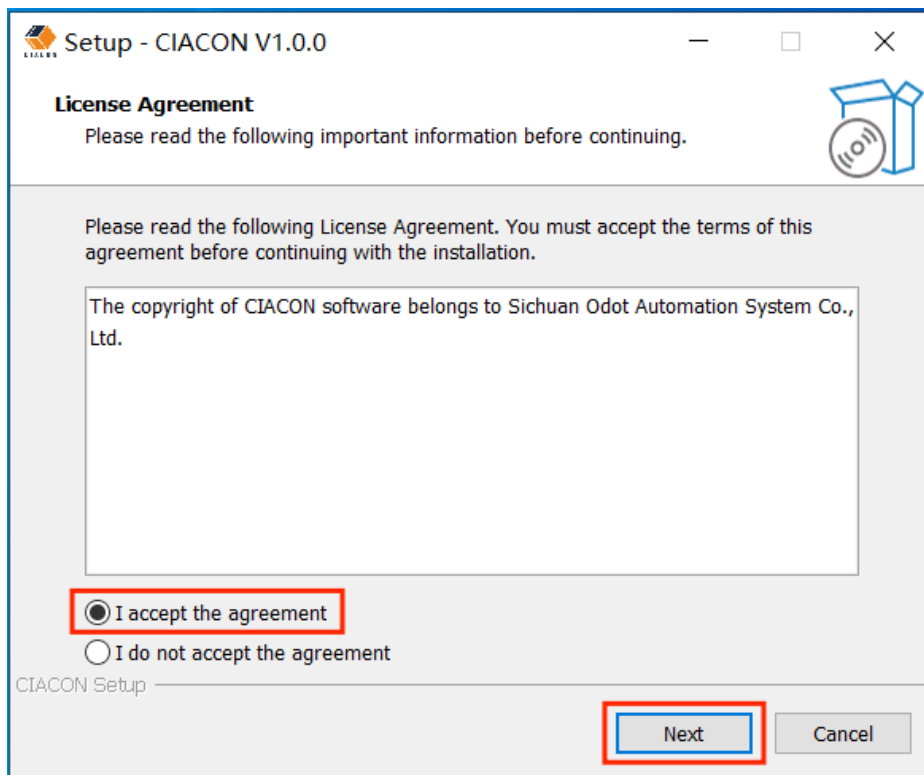

The installation file path can be modified, click Next.

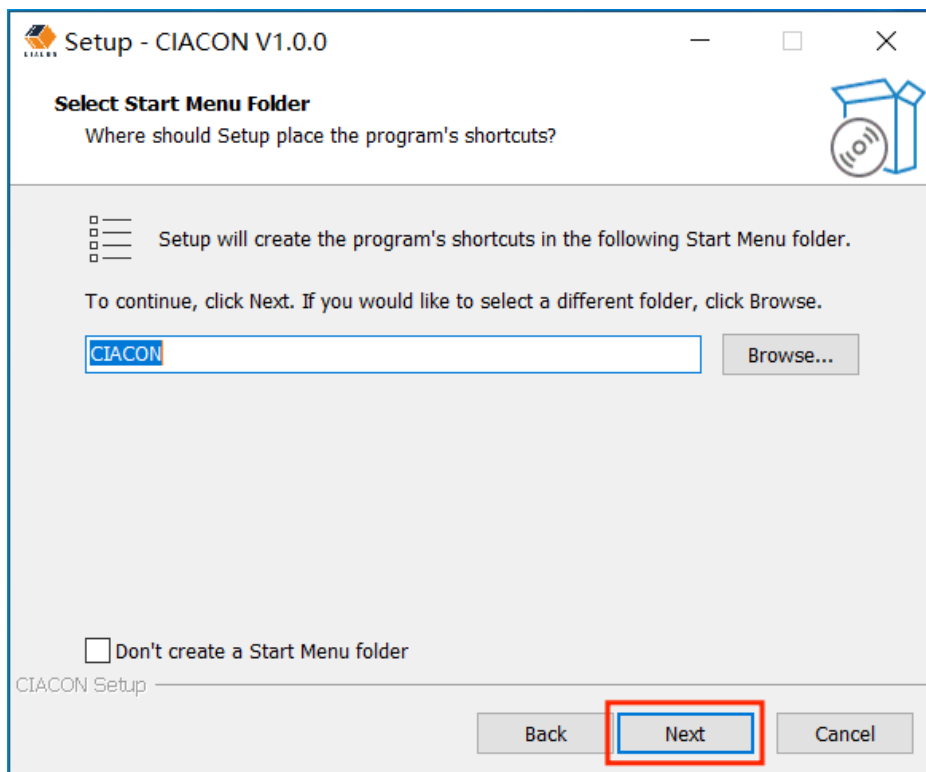
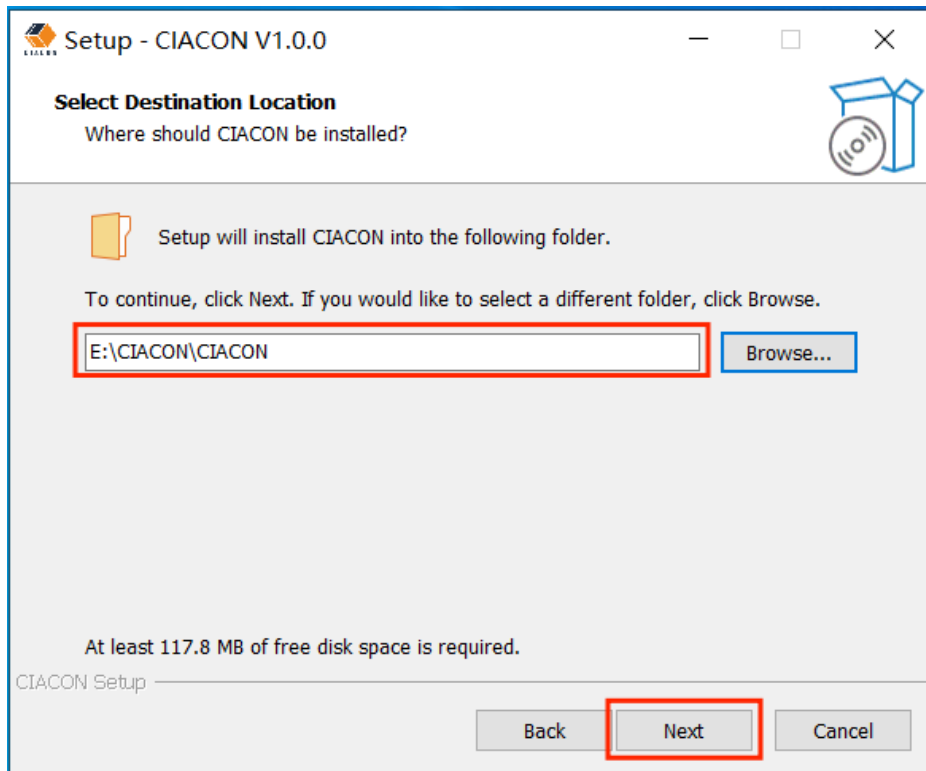

It could select an additional shortcut, and click Next.

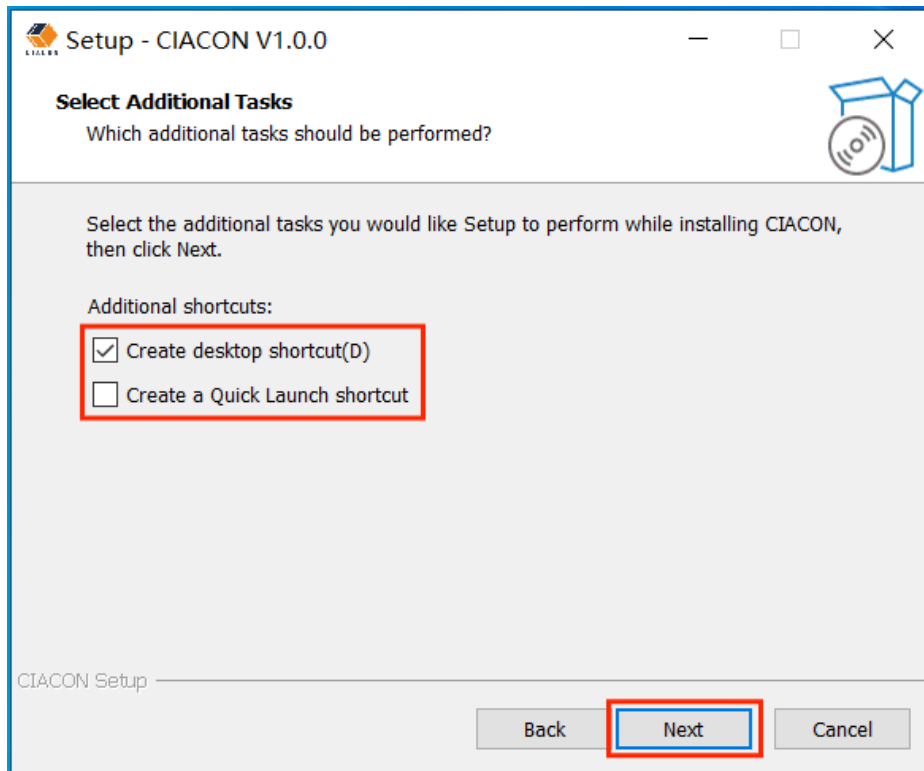

Click to install

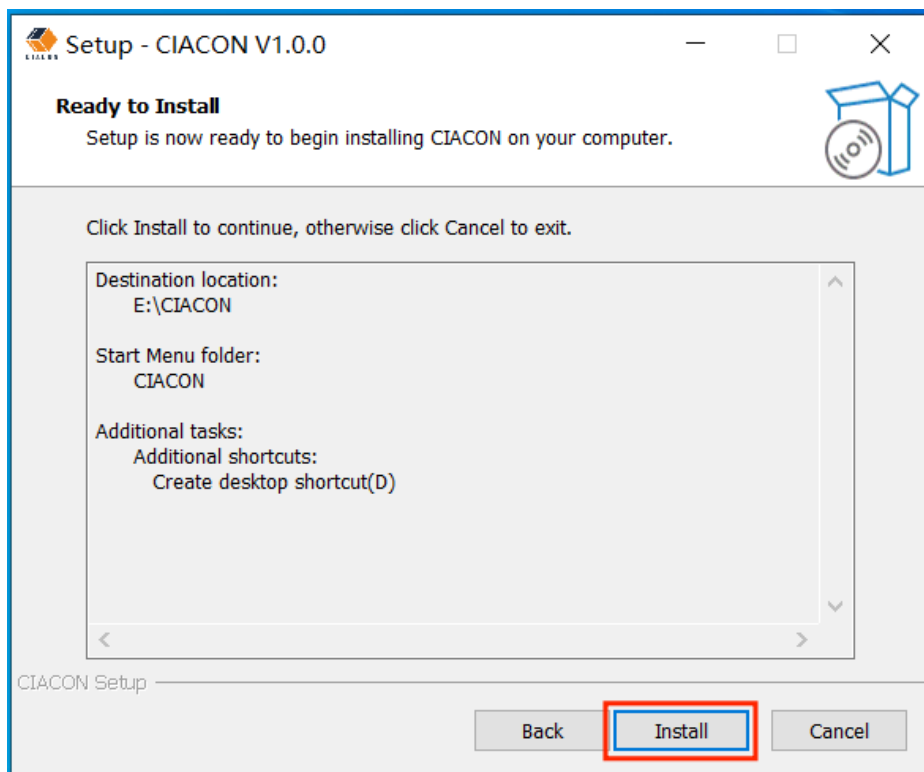

Complete the installation of CIACON programming software.

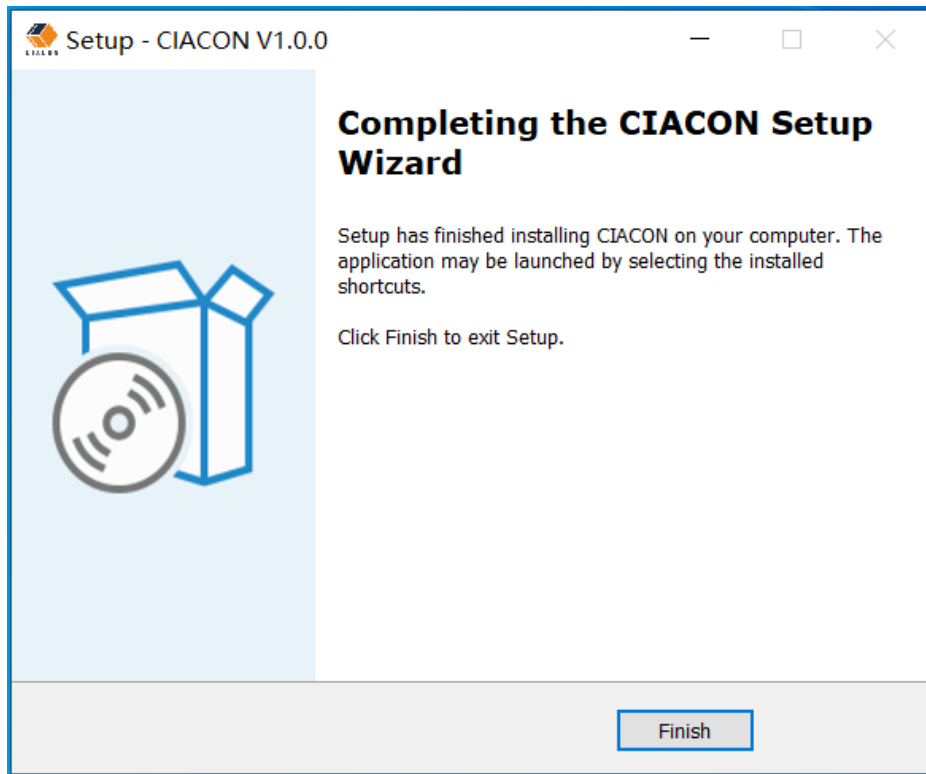

5.2 Applying of CIACON Software

5.2.1 Create New Projects

Click "New" in the upper left corner of the software → > Select PLC_0_Control → > Project name → > OK

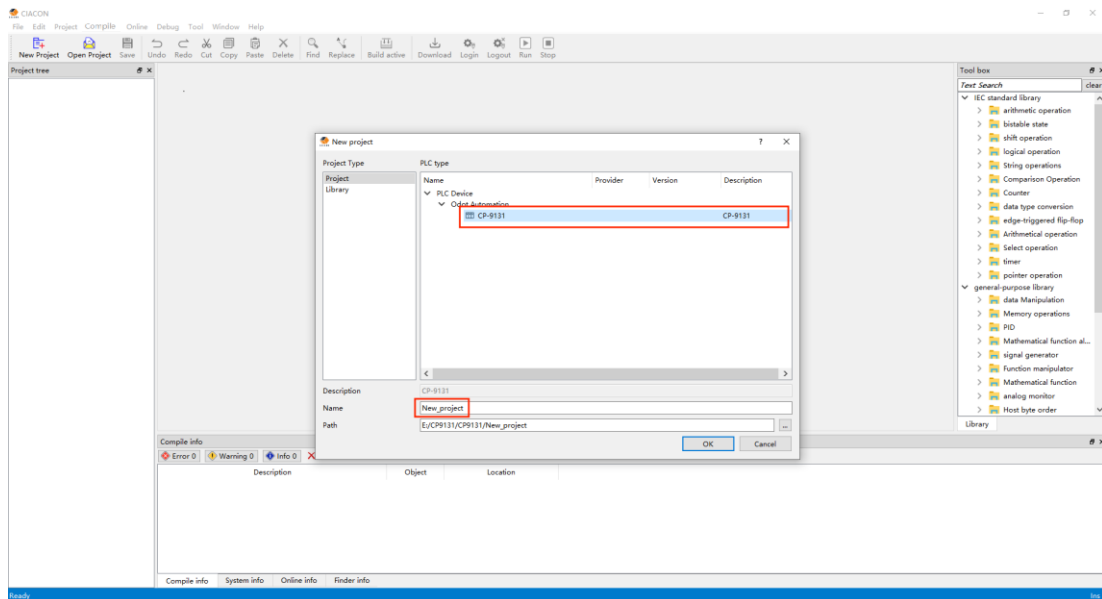

Select standard project and click OK

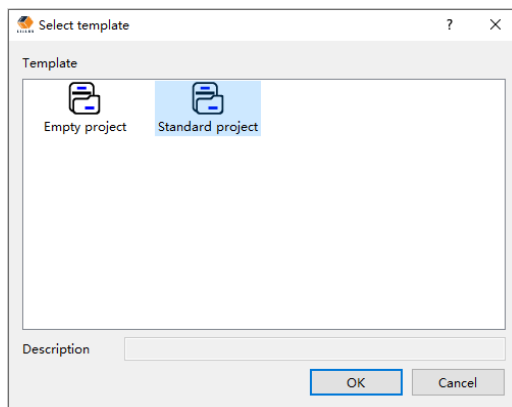

Name the device and click OK

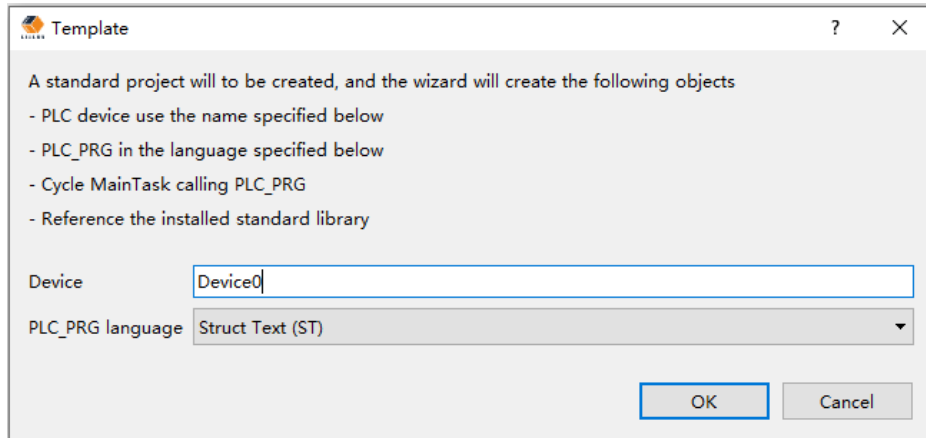

Click OK to complete the project creation.

5.2.2 CIACON Software Interface

Start CIACON software, and the main programming interface is shown in the figure below.

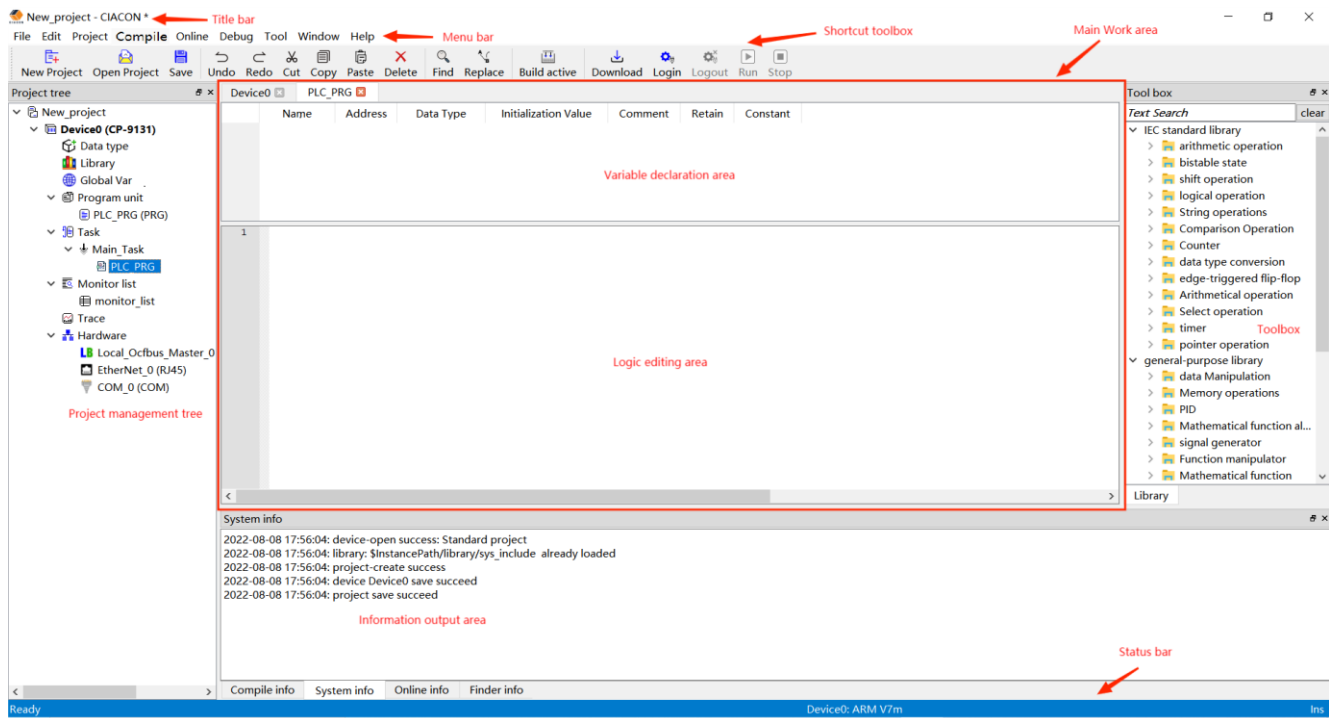

The main interface of CIACON software mainly contains the following contents:

Title bar: display the name of the opened project, whether to save and other states

Menu bar: includes all kinds of menu commands required by program operation. It is

divided according to the function of menu commands. For details please refer to CIACON software user manual.

Shortcut toolbox: includes common command buttons for program operation, grouped according to command types. For details please refer to CIACON software user manual.

Project management tree: including all elements in the project, displayed in a tree structure. For details please refer to CIACON software user manual.

Main Work area: This area is slightly different depending on the selected engineering elements. The image above shows the editing area of the program organization unit.

Other elements are described in details of the CIACON Software Manual; the area consists of two parts:

Variable declaration area: it displays variable information defined in this POU or global variable group. Users can add, delete, and modify variables in this area. To be displayed by table is more intuitive and easier to operate.

Logic editing area: it displays the control logic of the POU, graphical language in the form of graphics, text language in the form of text editing, and it provides syntax highlighting, program indentation, folding and other functions, easy for program reading and programming.

Toolbox: Contains two parts:

The algorithm library page provides the system default library and all program organization units that referred the custom algorithm library, which is convenient for users to call efficiently by dragging and dropping.

The other page provides a shortcut kit for graphical language editing based on the current operating language.

Information output area: contains Compile info, System info, Online info and Finder info. The compiling error message and finder information could provide double-click

locating function.

Status bar: displays the status of the current project, including the controller model and project status. When online, different colors will be displayed alternately according to different status of the controller, so that users can see the project status at a glance.

The CIACON software manual will describe each functional area in detail.

5.2.3 Configure I/O module

Double-click the device name and select communication Settings. Select the whole network segment and click Scan. After the device is scanned, double-click the IP address, the IP address will be automatically filled with the IP position configured for communication. Or it could directly enter the IP address of the PLC device in the IP address area.

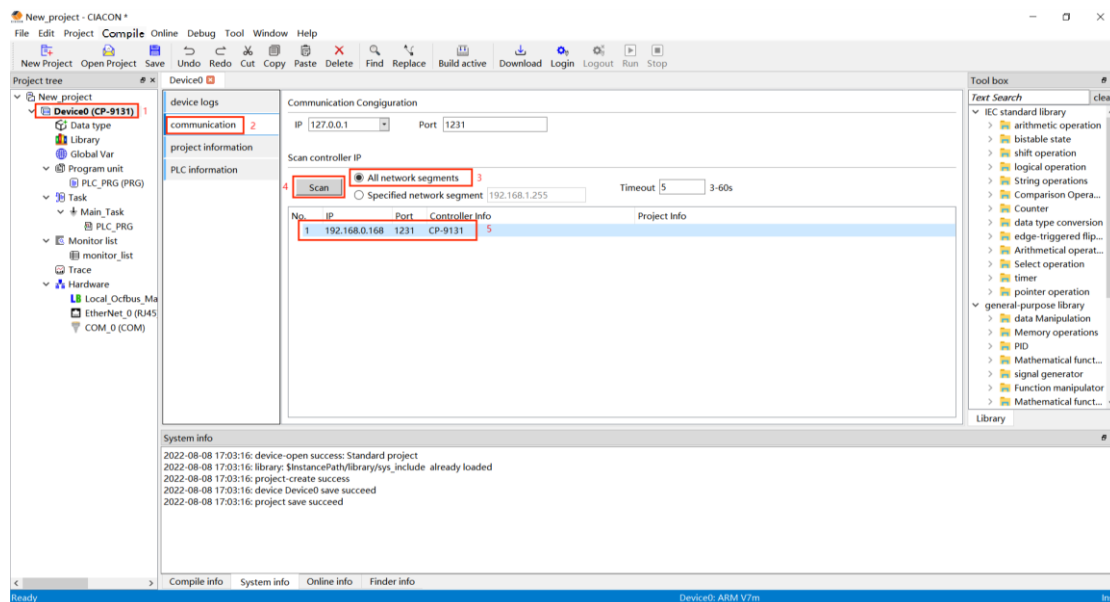

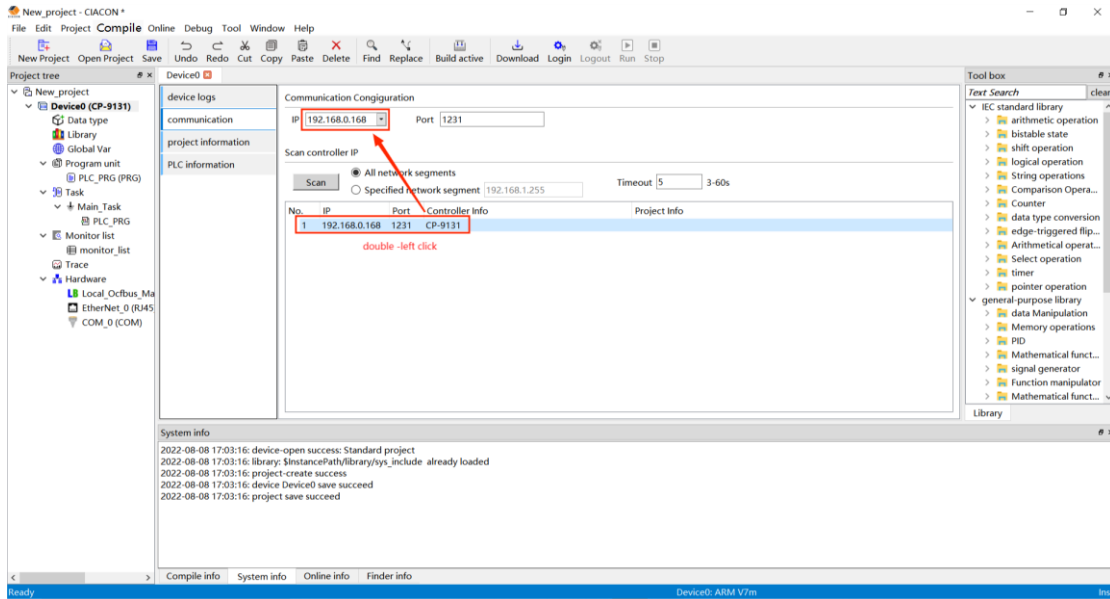

Right click Local_Ocibus_Master under bus configuration and click Add Module.

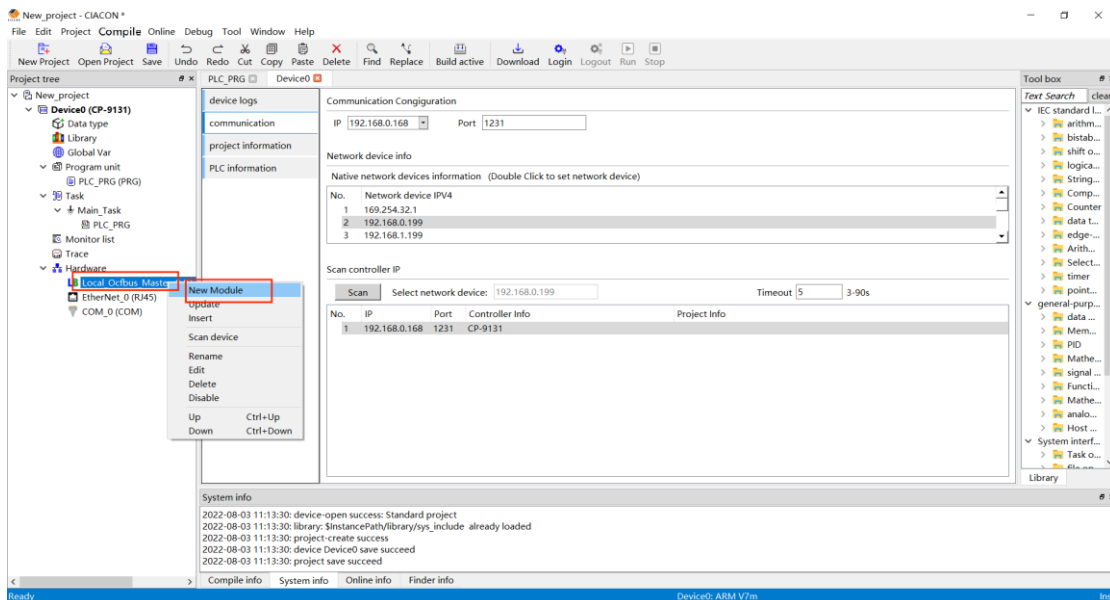

In the popup dialog box, it needs to add the corresponding modules based on the actual I/O module configuration model and sequence.

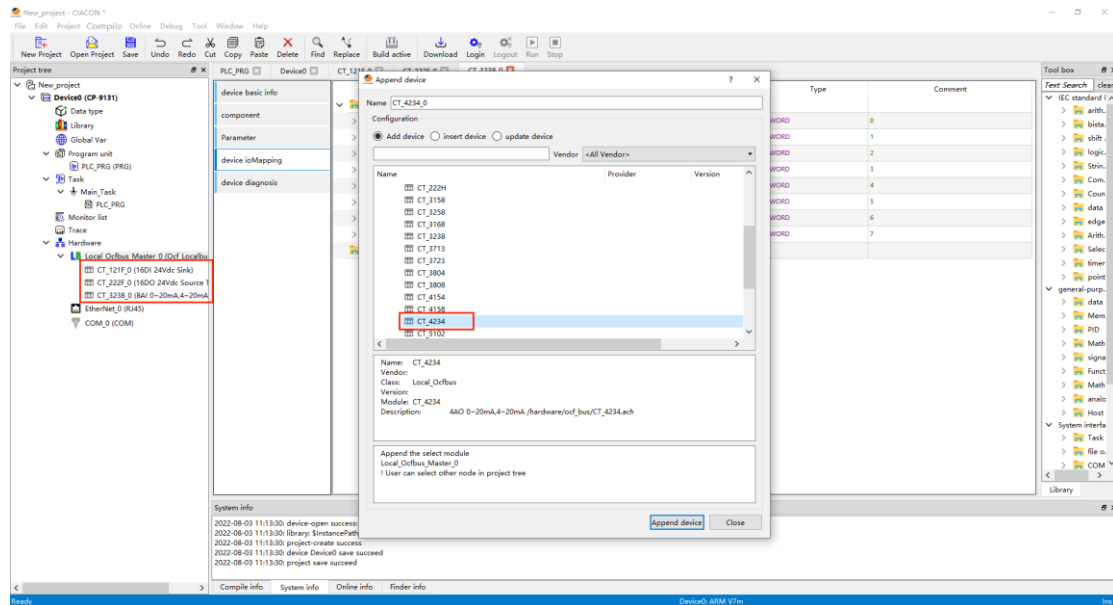

After the module configuration is completed, it could click the corresponding module, select I/O mapping configuration, and click the arrow to view the IP address automatically assigned to the I/O module by the system. And it could specify the IP address based on the uppermost IP address.

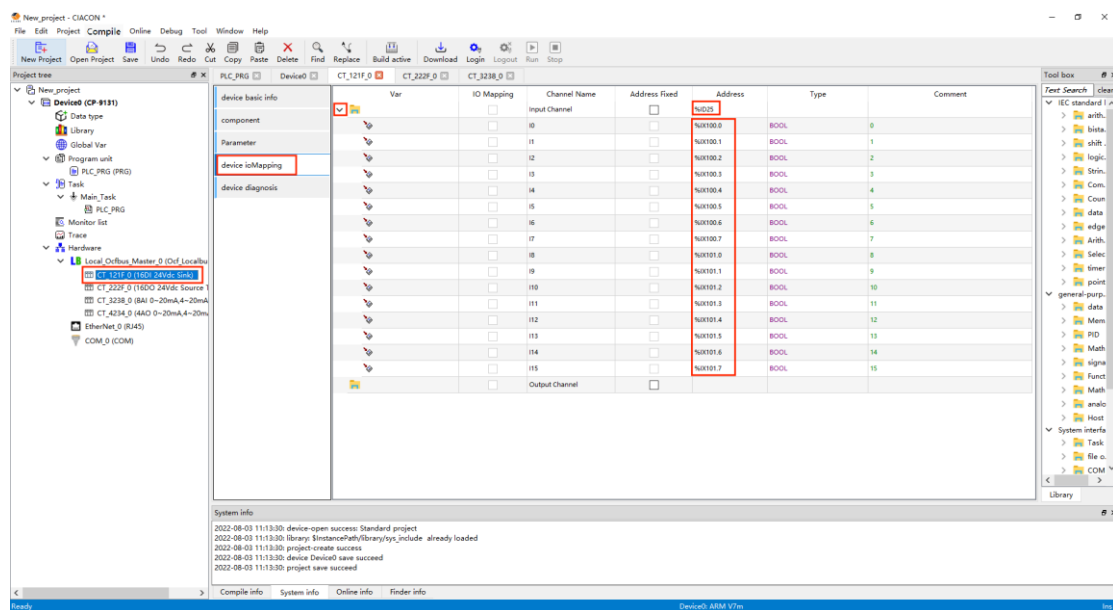

Now the IO module configuration and address assignment are completed.

5.3 Programming

In the Project Management tree, it could double-click the PLC_PRG under the program organization unit.

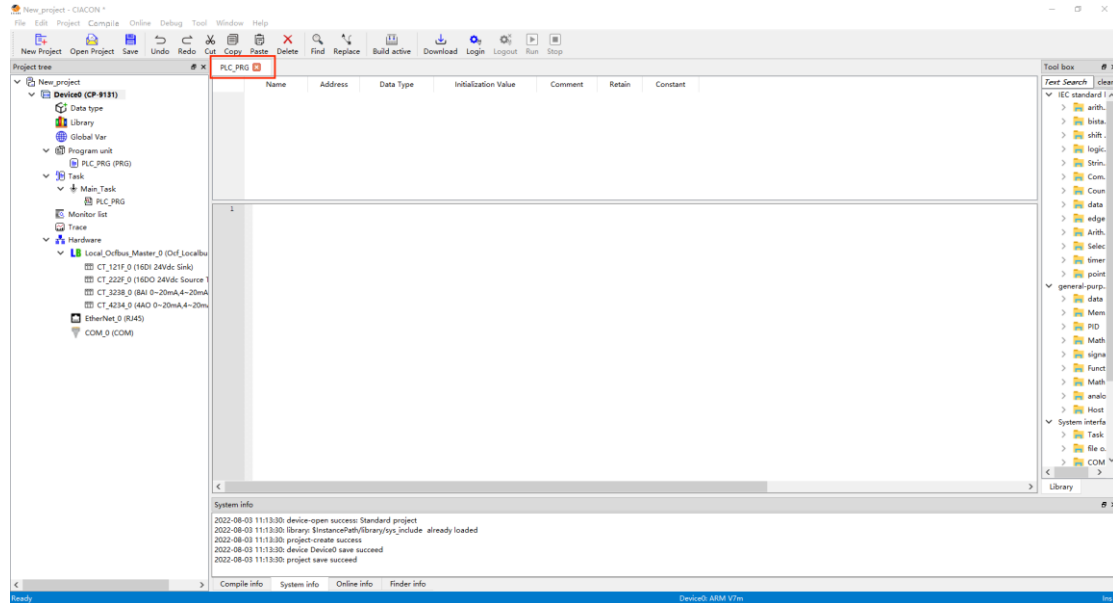

At first it needs to create a simple program where the intermediate variable is equal to the input module channel value.

%qx100.0 corresponds to the DI0 of CT-122F, and the intermediate variable "start" is equal to the value of DI0. After press enter, it will have popup dialog box for automatic variable declaration. Then it could select BOOL data type to complete the creation of the variable.

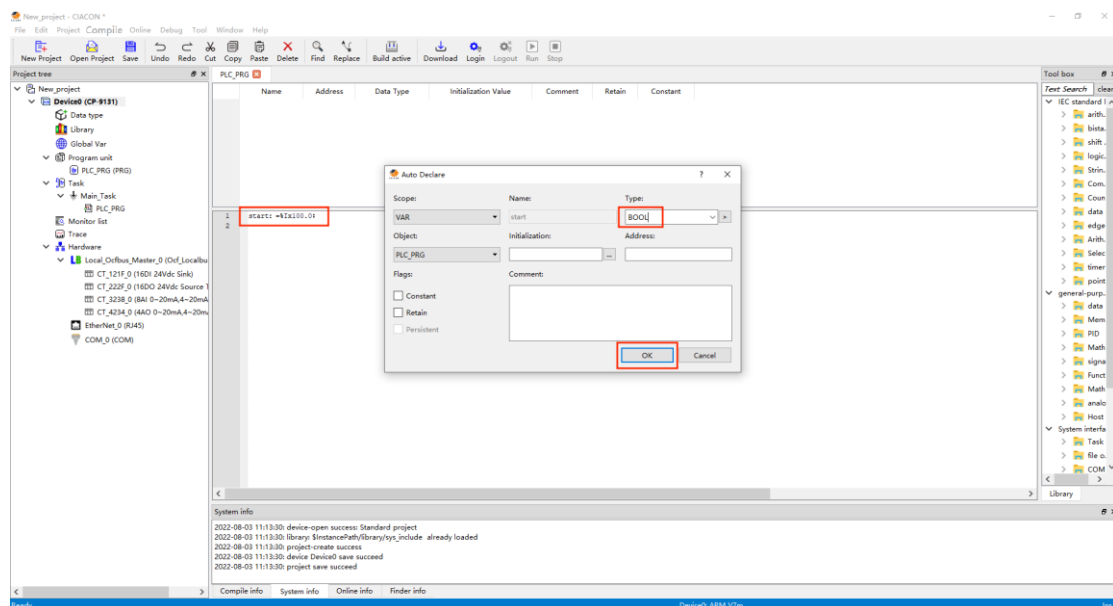

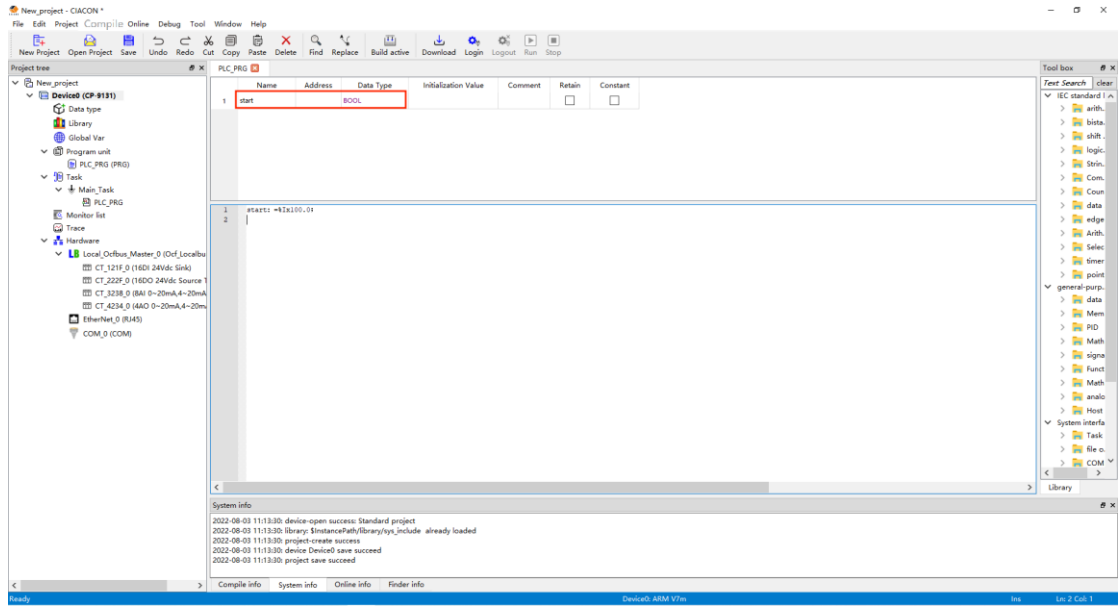

Click Compile, and after the compile is done, it could download the configuration and download the program.

5.4 Download and monitor

After the PLC programming is completed, it could select Compile at the top of the software interface and click Recompile. And the system will prompt: "Clear compile will due to clear the download (clearing the controller), do you want to continue?"

Now click OK to start compiling.

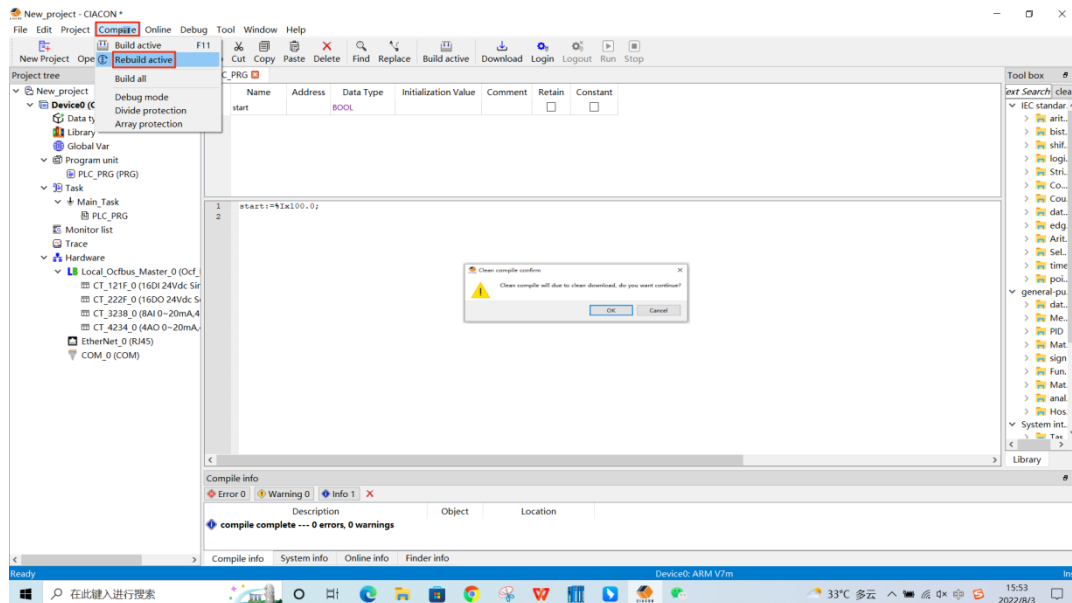

After the compilation, information about the current program size will appear at the bottom of the software interface.

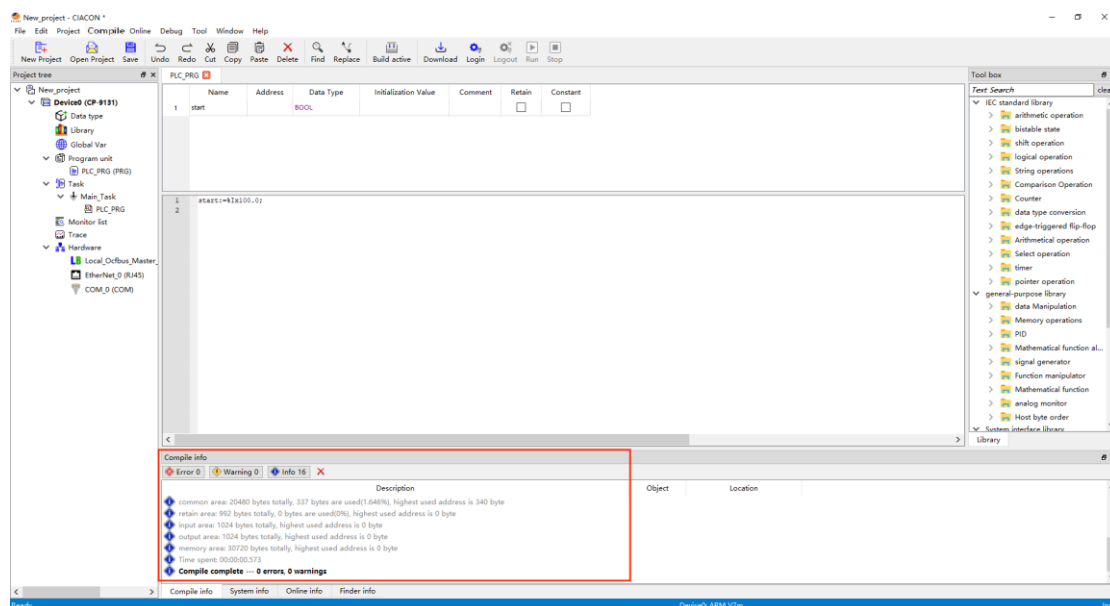

Then click the "download" button at the top of the software interface, the software will automatically match the corresponding PLC according to the IP address set in the communication Settings. And it will pop up dialog box to select clear the download, and then click OK meanwhile a confirmation dialog box will pop up again, please click OK too. Now the PLC stops running and it will automatically resume running after the download is completed.

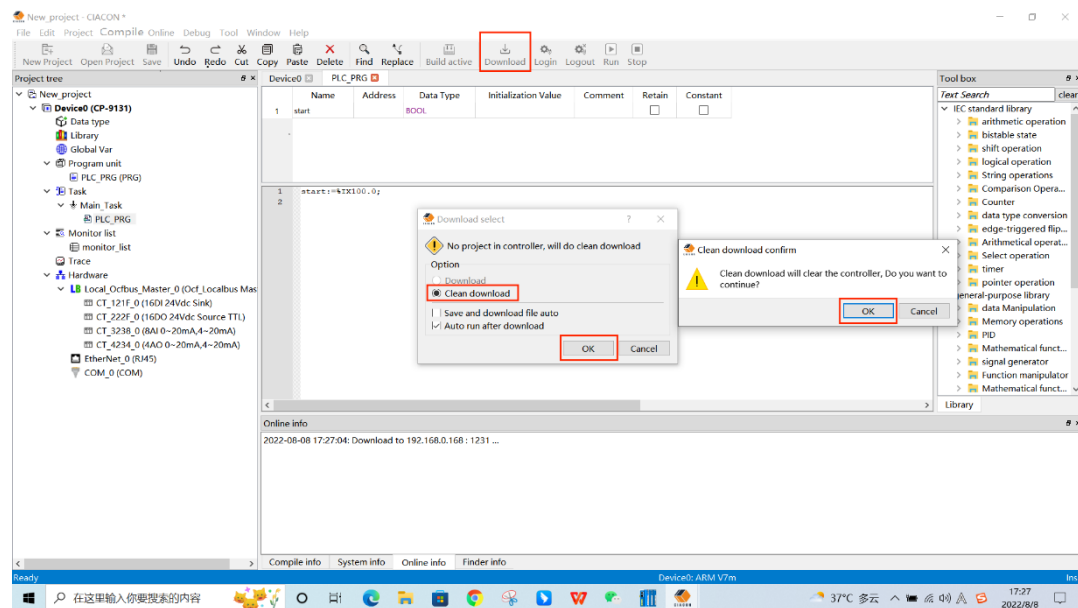

When the progress bar is full, the program is downloaded. It could click the "Login" button at the top of the software interface to run the program online and monitor the running status of PLC and the program in real time.

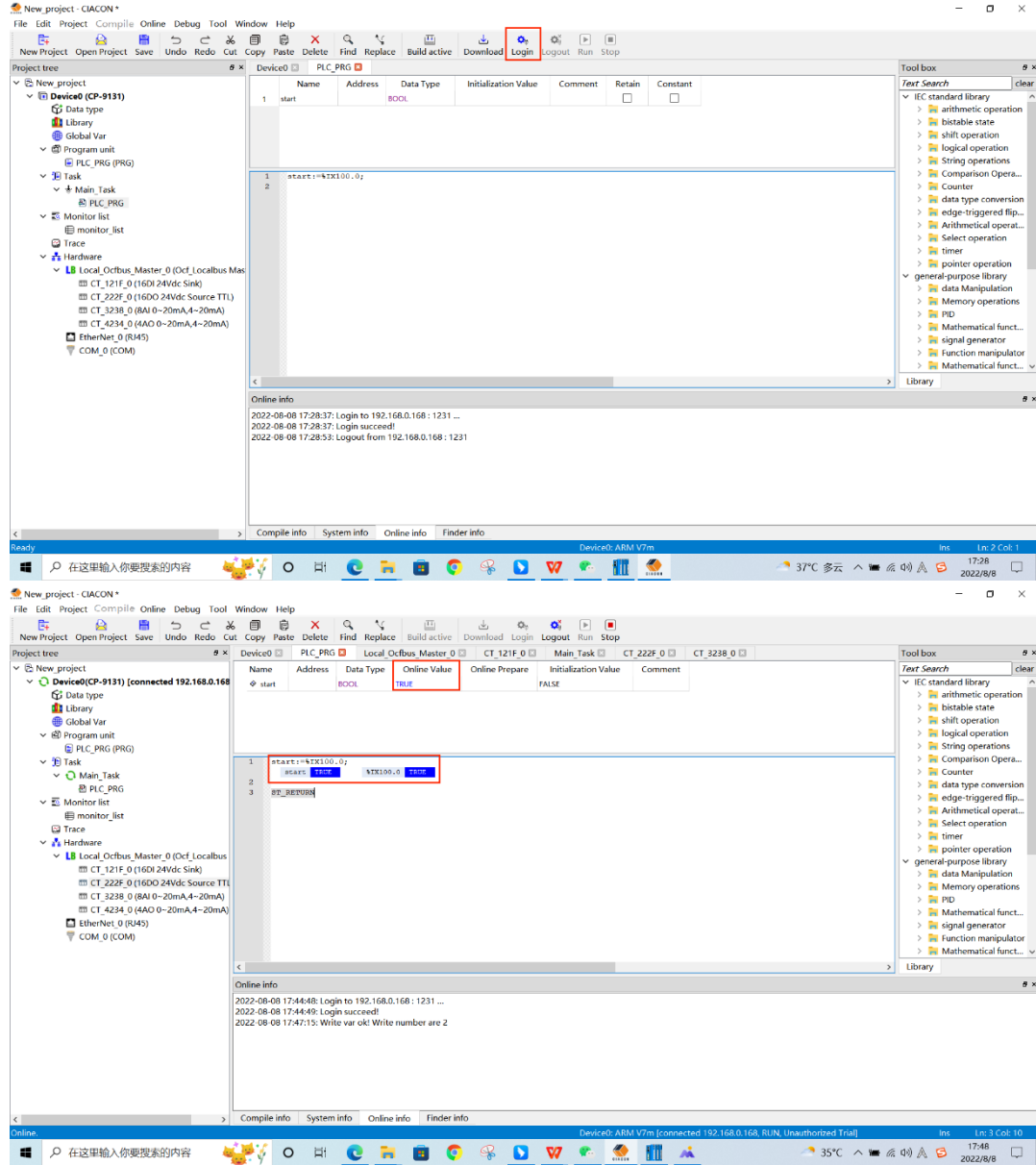

5.5 Master Function

It needs to double-click EtherNet_0 (RJ45) to set the basic parameters of the Ethernet port. Clicking the Ethernet port name and it could display the device Ethernet port name in the popup window, then select the Ethernet port and click OK.

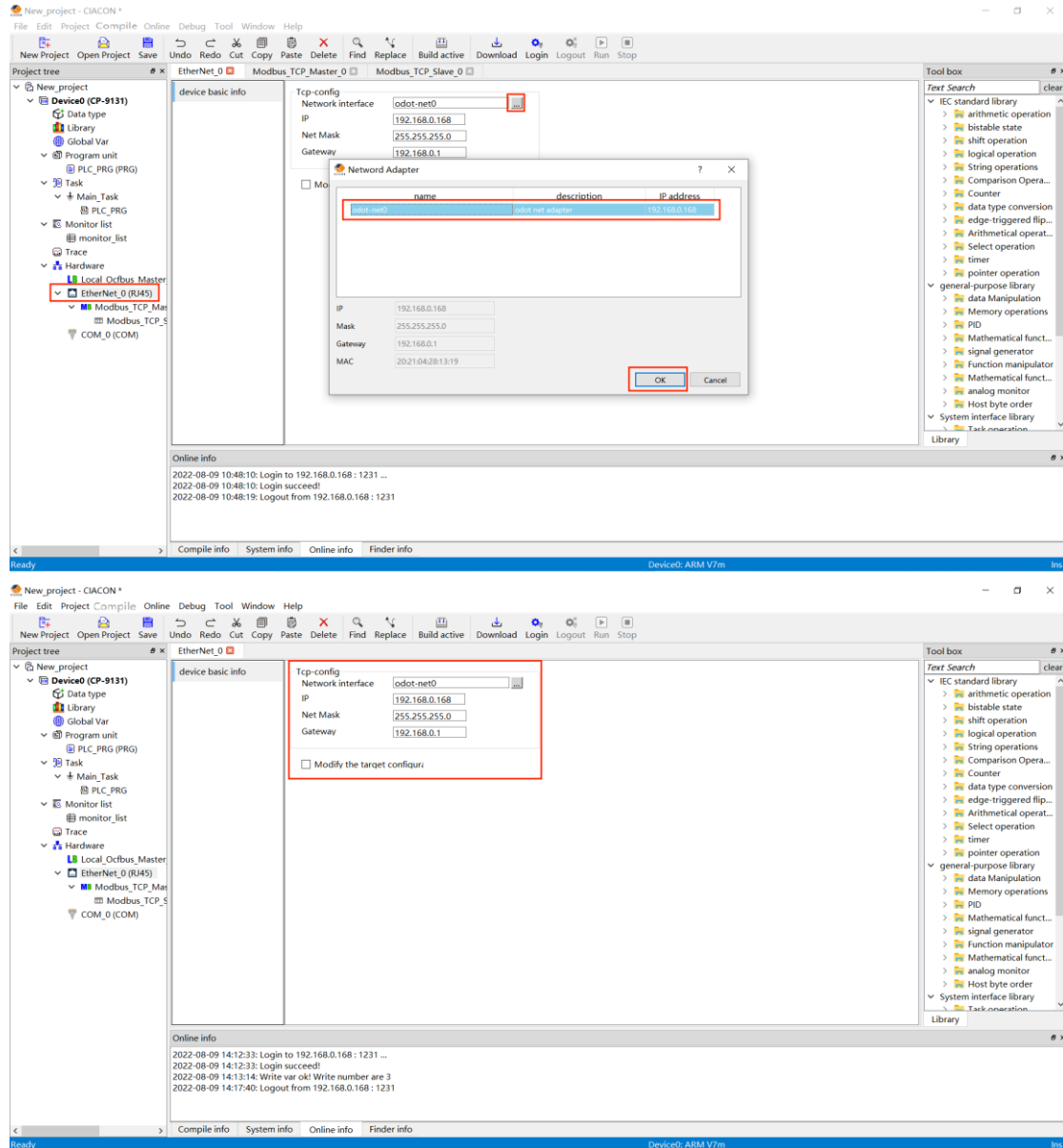

Right-click the EtherNet_0 (RJ45) and choose to Add module device. Then choose Modbus_TCP_Master in the Modbus master and click Add device.

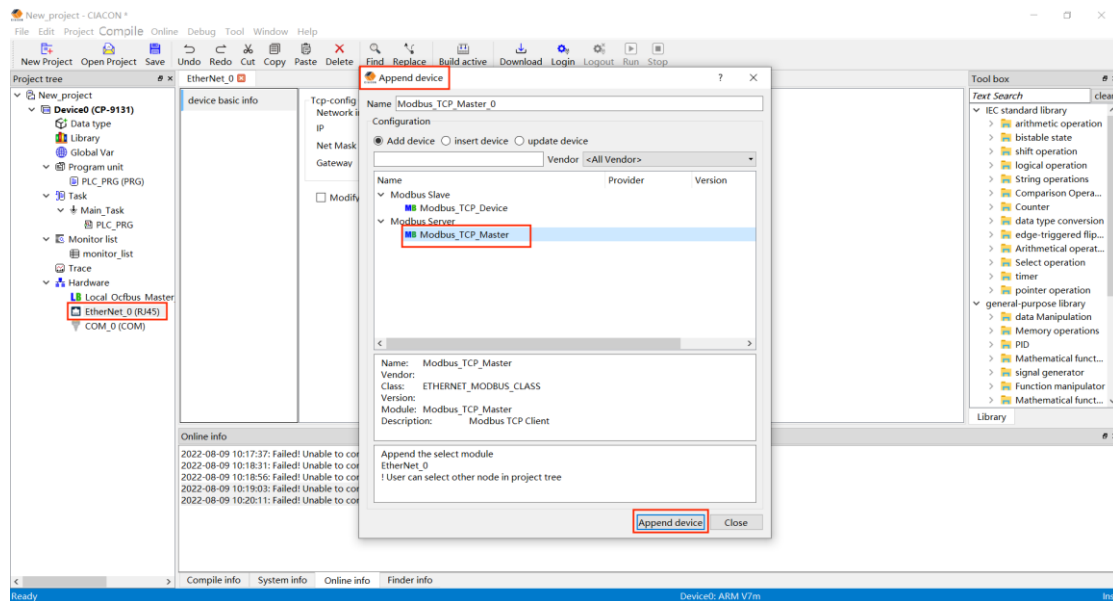

Double-click Modbus_TCP_Master to view the parameter Settings of the Master.

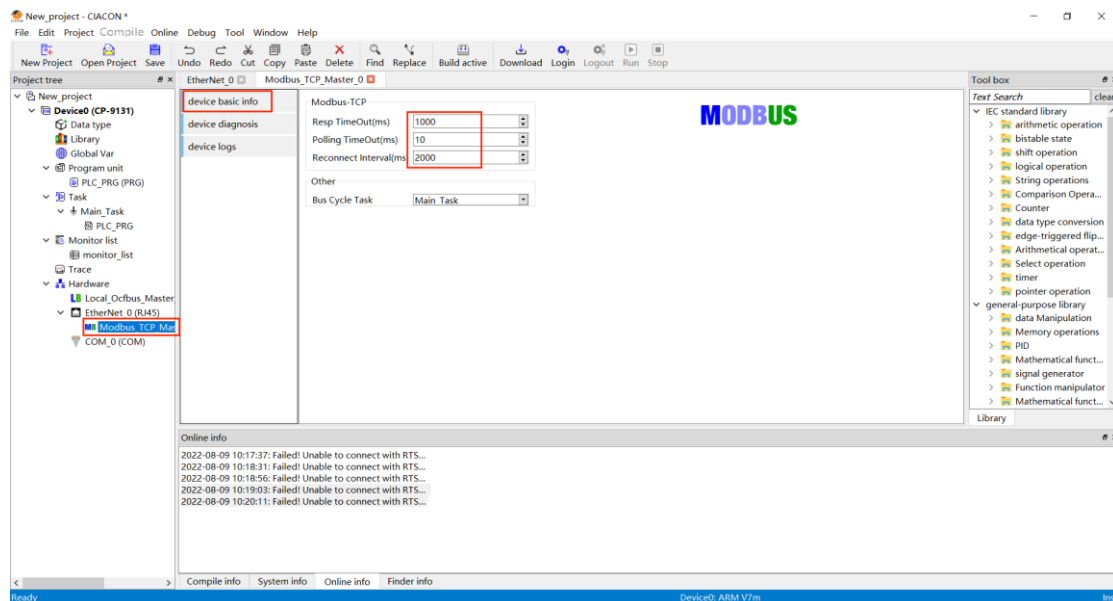

Right-click Modbus_TCP_Master and it could click Add device. In the popup window it could select Modbus_TCP_Slave and click Add device.

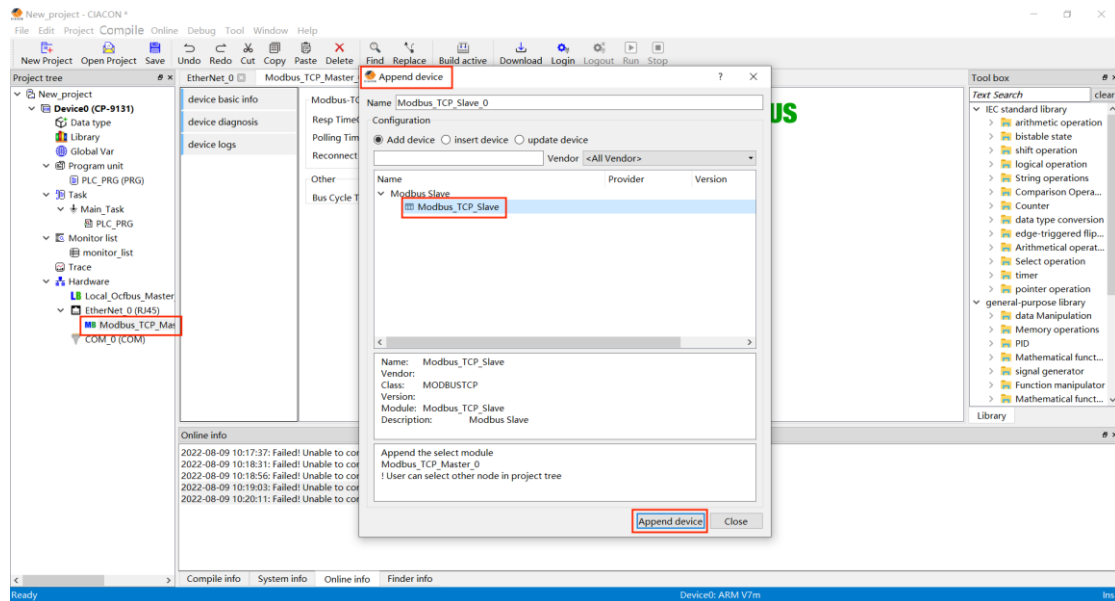

Double-click Modbus_TCP_Slave to set the parameters of the Slave devices.

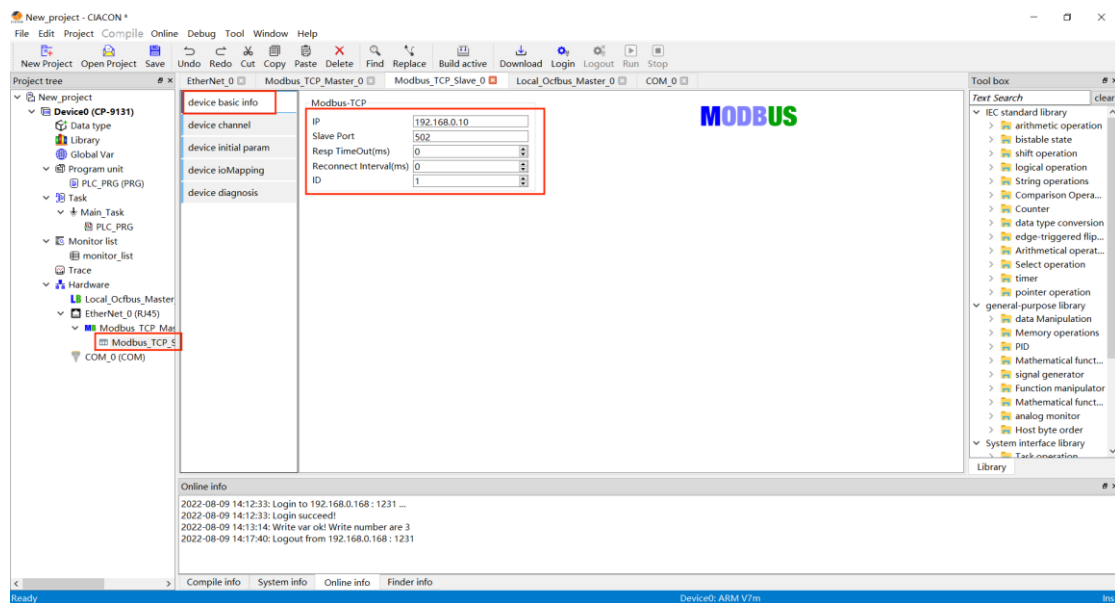

Click device channel and it could right click add in the blank. Then in the popup window, it could set the function code, start address, data length of the data that needs to read and write from the slave.

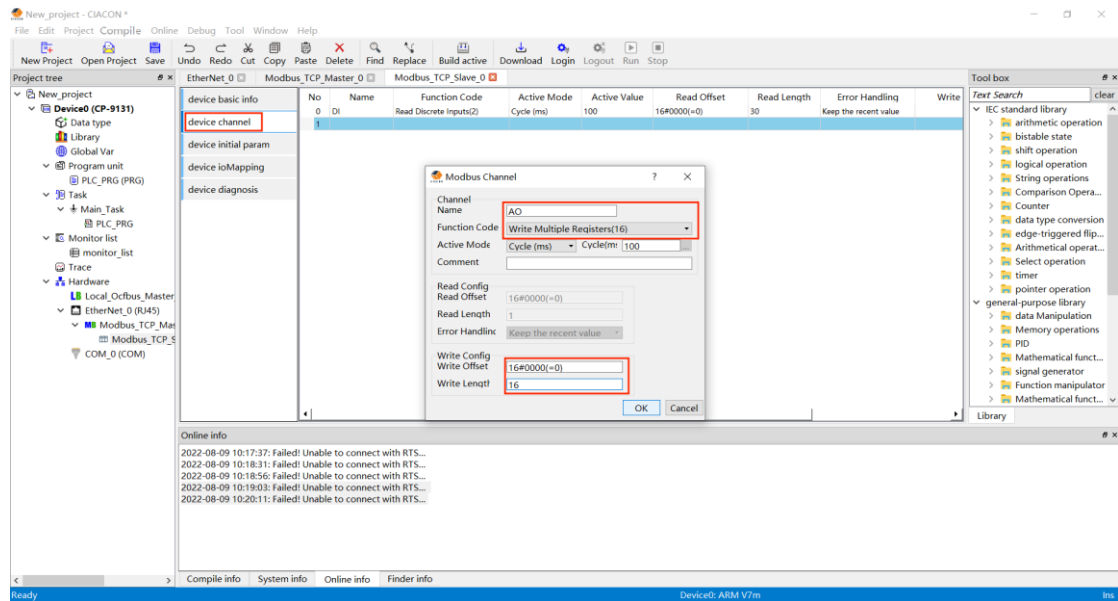
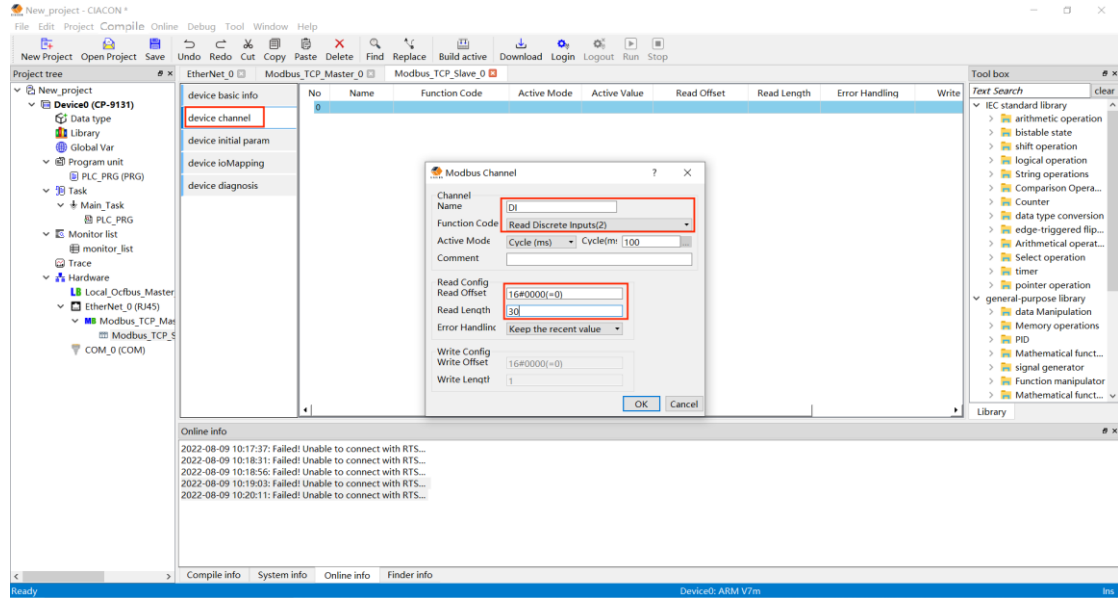

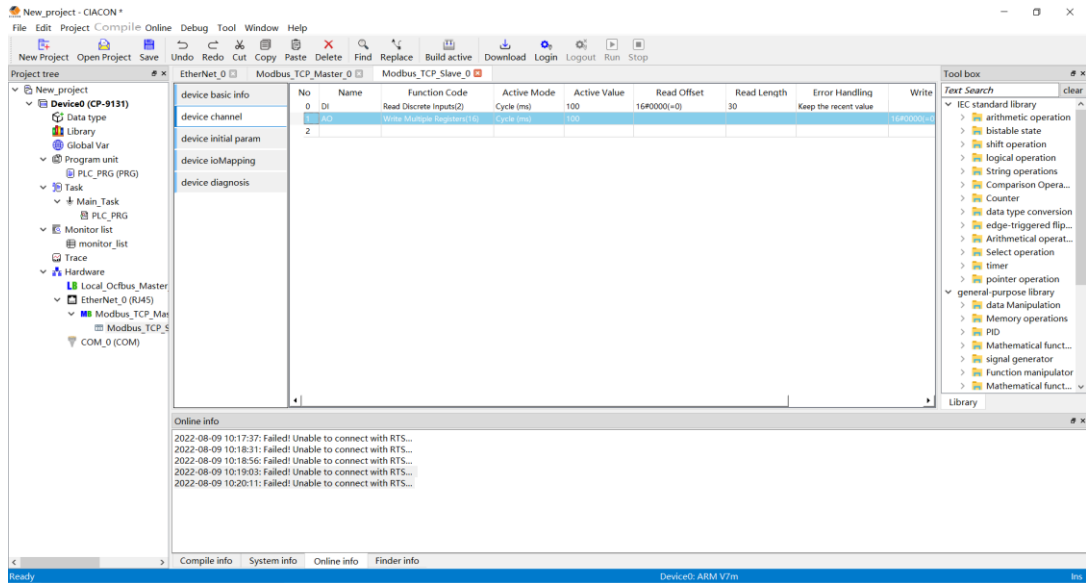

After configuring the communication commands, it could select I/O mapping configuration to view the data address of the I/O mapping.

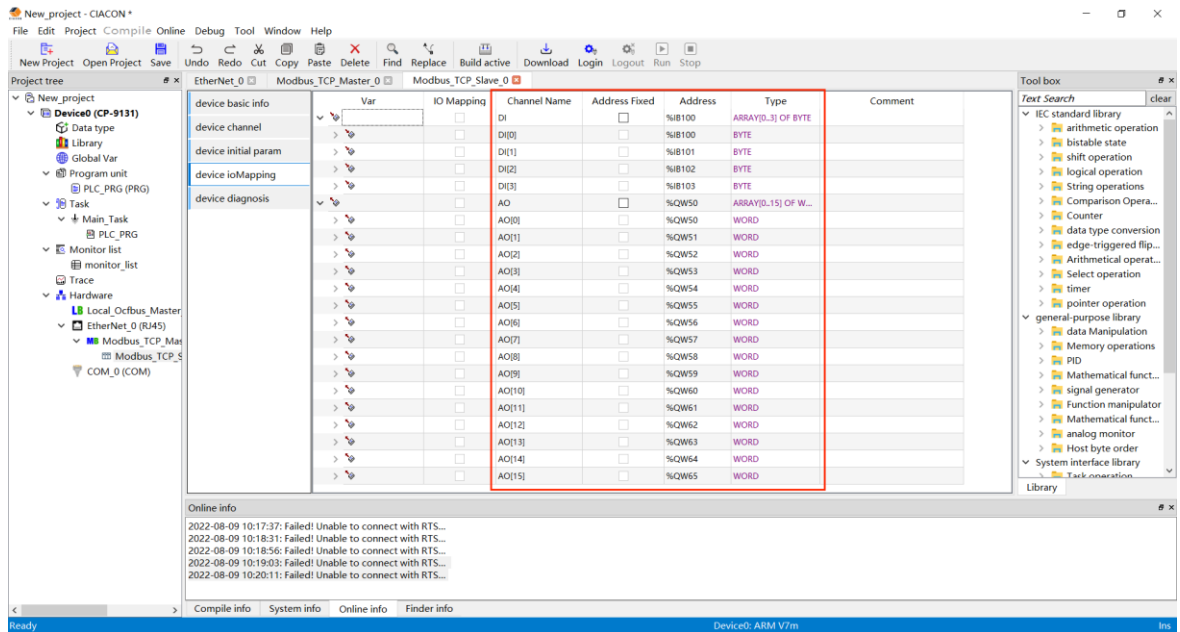

Now the MODBUS TCP master function configuration is completed. It needs to click Compile, re-compile, and confirm:

"Clear compile will due to clear the download (clearing the controller), do you want to continue?" Now click OK and it will start compiling. After compiling, please click download.

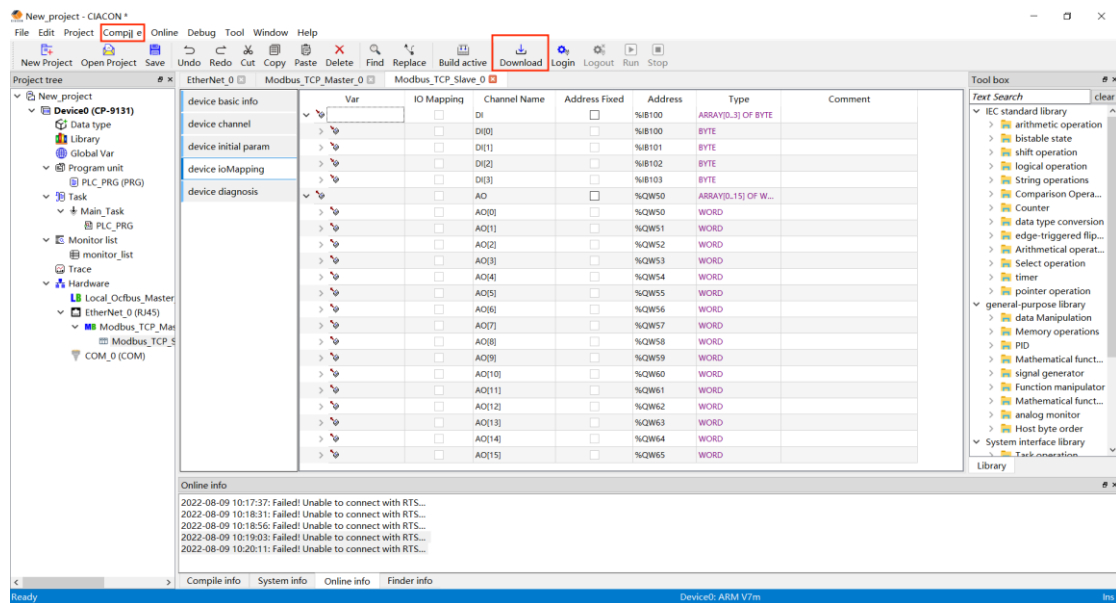

After the download is completed, it could open Modbus Slave to simulate the Slave device of Modbus TCP to test this function.

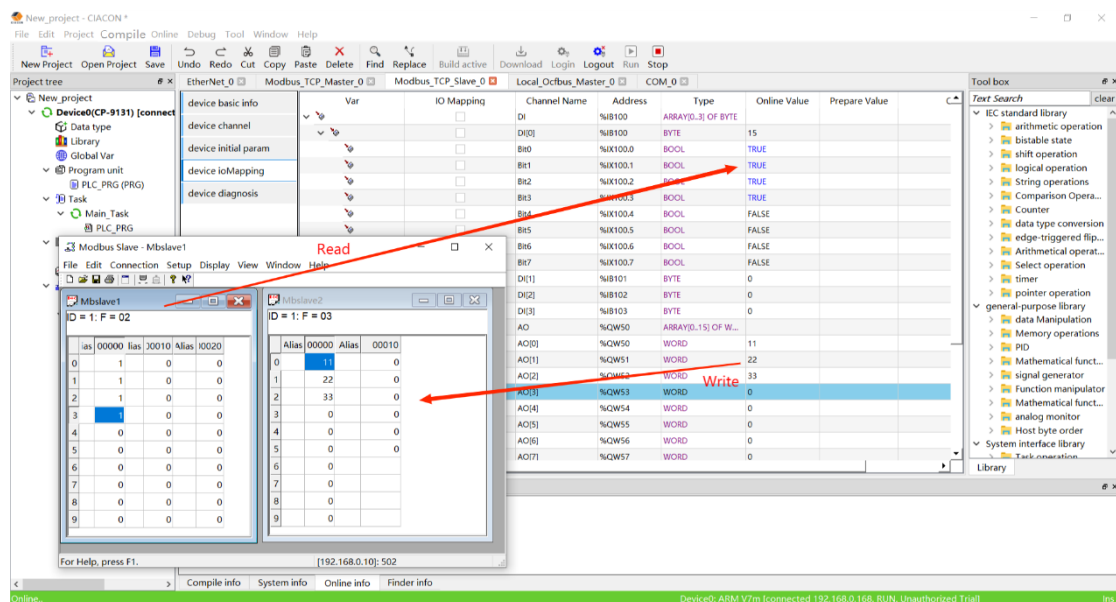

5.6 Modbus TCP Slave Function

It needs to double-click EtherNet_0 (RJ45), and set the basic parameters of the Ethernet port. Clicking the Ethernet port name and it could display the device Ethernet port name in the popup window, then select the Ethernet port and click OK.

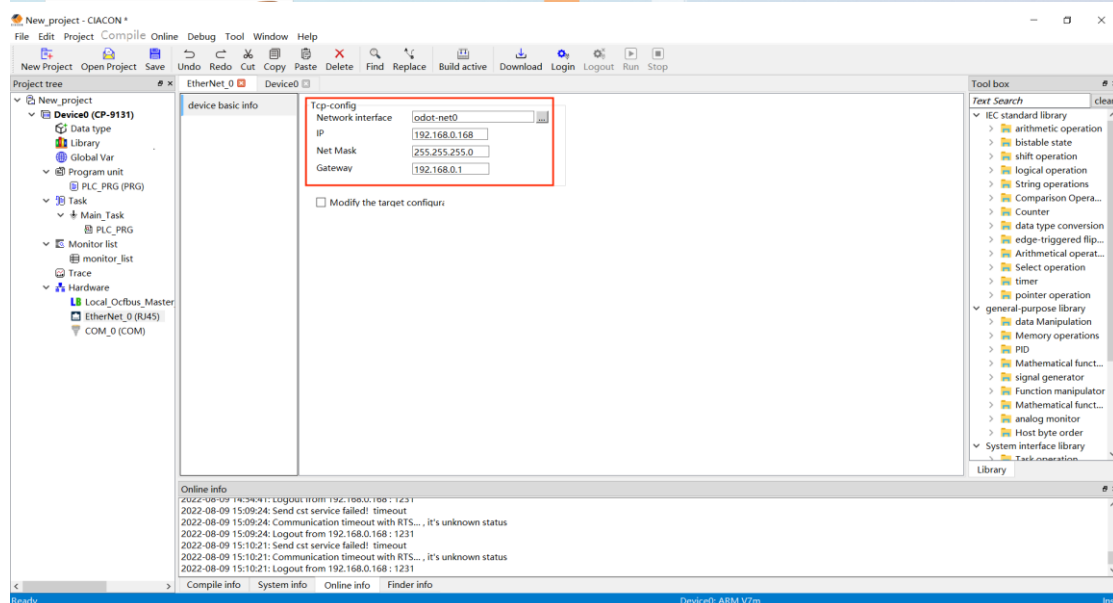
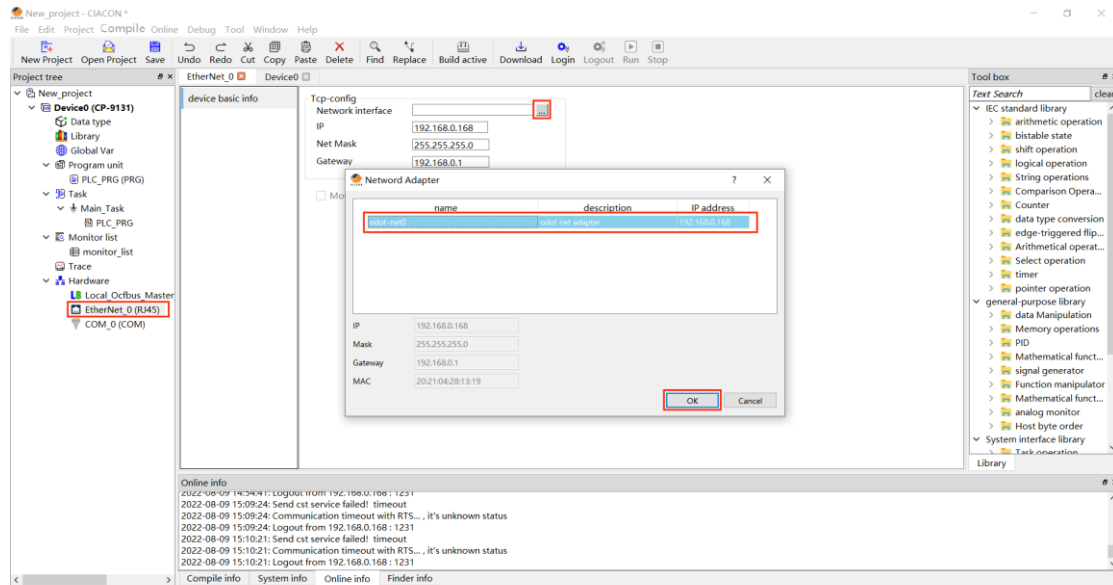

Right-click the EtherNet_0 (RJ45) and choose to Append device. Then choose Modbus_TCP_Device in the Modbus slave and click Append device.

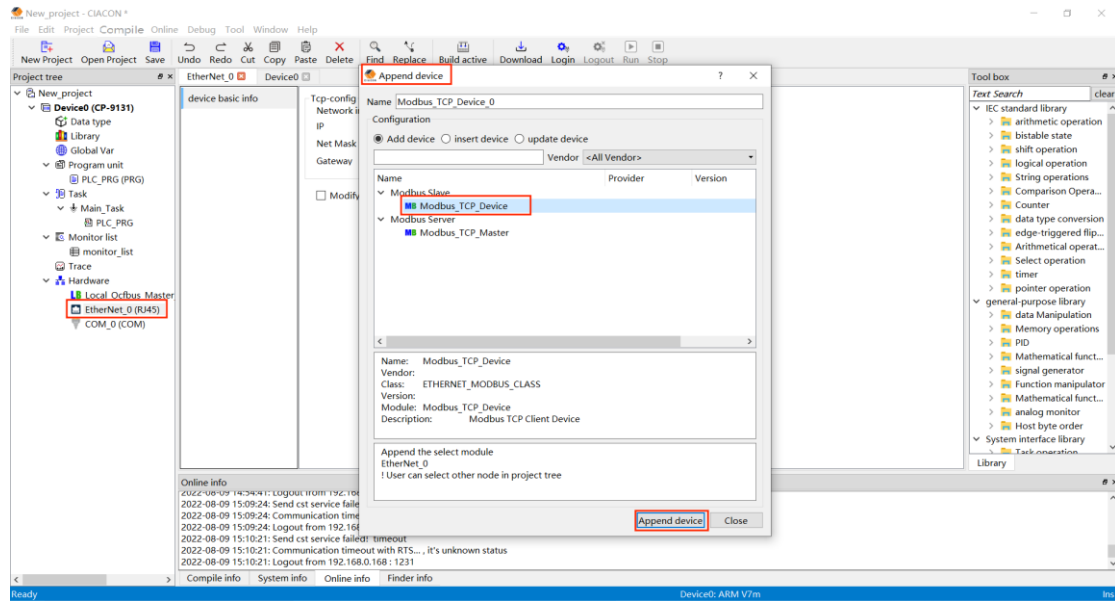

After the device adding, it needs to double-click the newly created modbus_TCP_Device for slave devices, and it could view related parameters in device basic info. Timeout period: 1000ms, port number: 502, number of connections: 5 (supports simultaneously access of 5 pcs of MODBUS TCP clients), associated Task: Main Task.

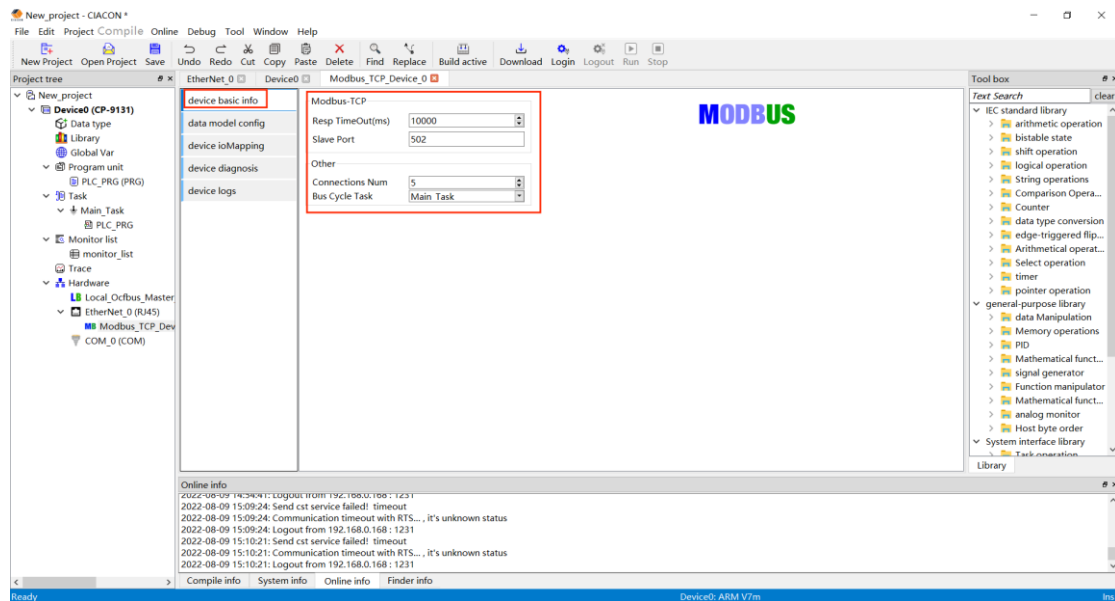

Click data model config, and it could create a mapped MODBUS address area.

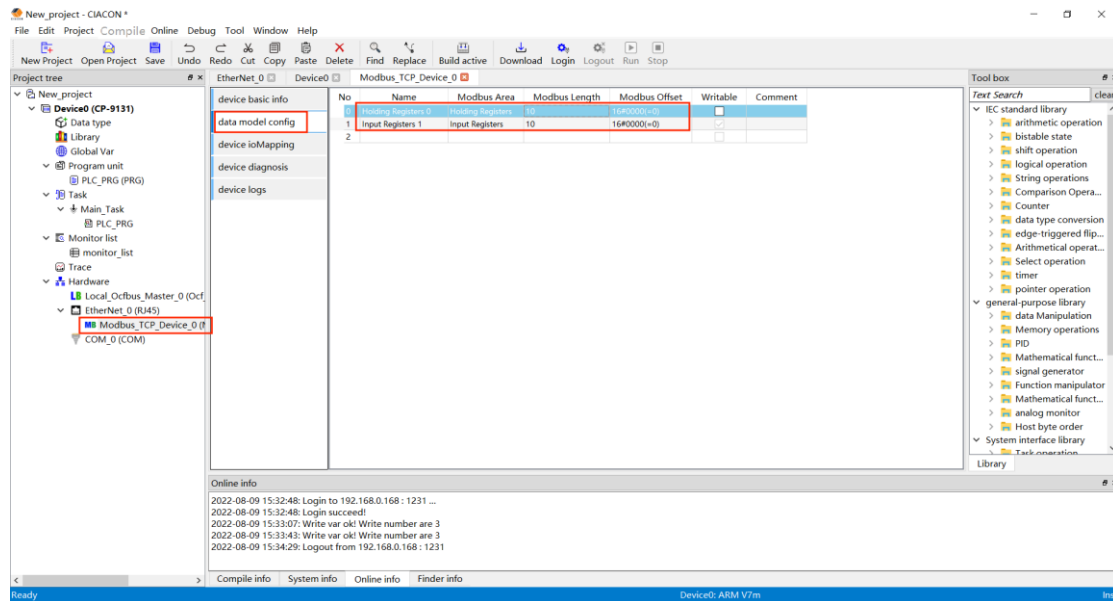

After selecting device IO mapping, it could onfigure the corresponding PLC data address after modbus address mapping. And it could set the start address of mapping data in the address.

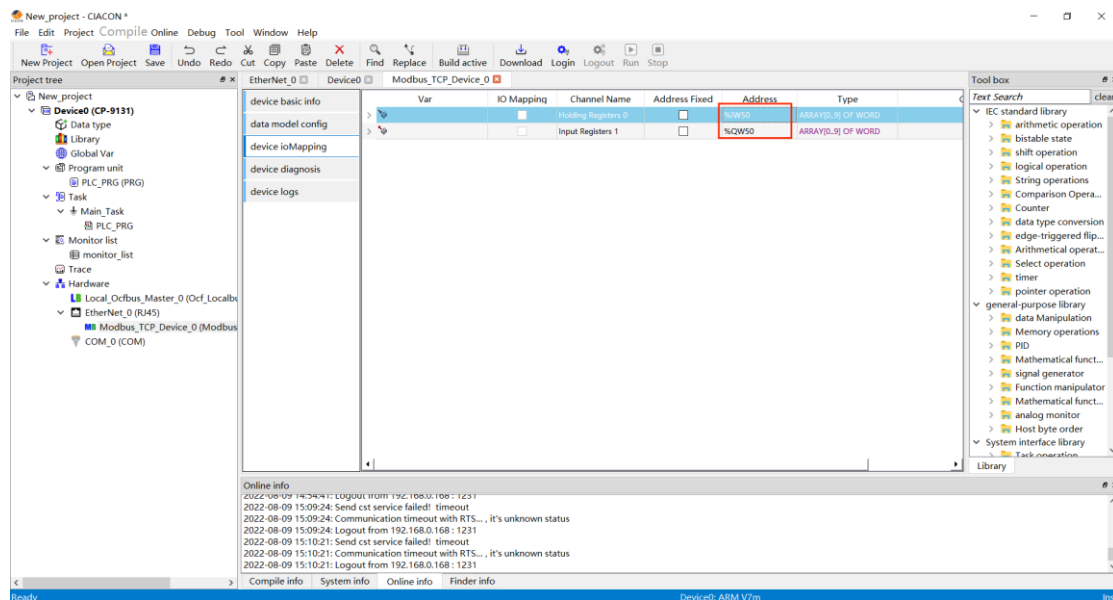

Now, the PLC MODBUS TCP slave function configuration is completed. Click Compile, re-compile, and confirm: "Clear compile will due to clear the download (clearing the controller), do you want to continue?" Now click OK and it will start compiling. After compiling, please click download.

After the download, open the MODBUS Poll, the debugging software of the MODBUS TCP client, so it could collect data in the registers.

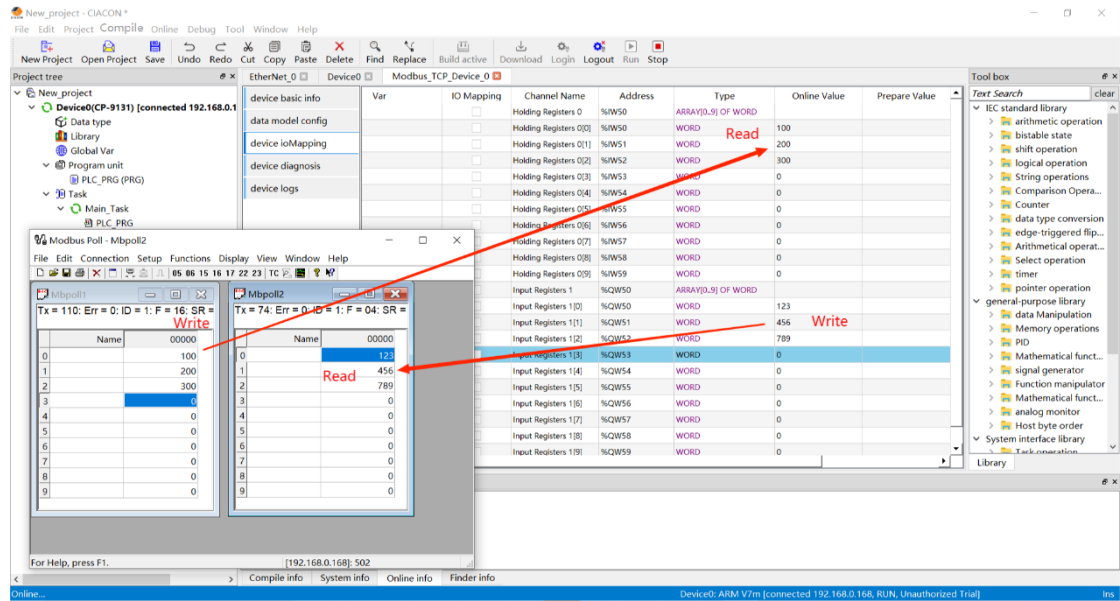

5.7 Modbus RTU Master Function

Double-click COM_0 to view serial port configuration parameters. The default values: RS485, 9600bps, E, 8, and 1.

COM type: RS485.

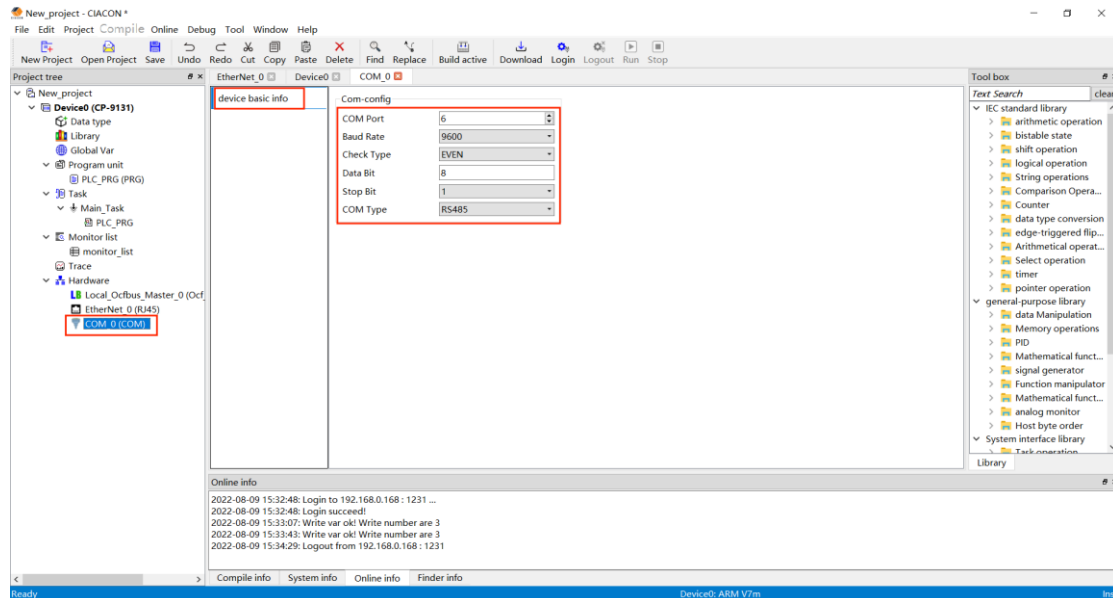

Right-click COM_0, and it could select Append module, then select Modbus_COM_Master under Modbus master, and click Append Device.

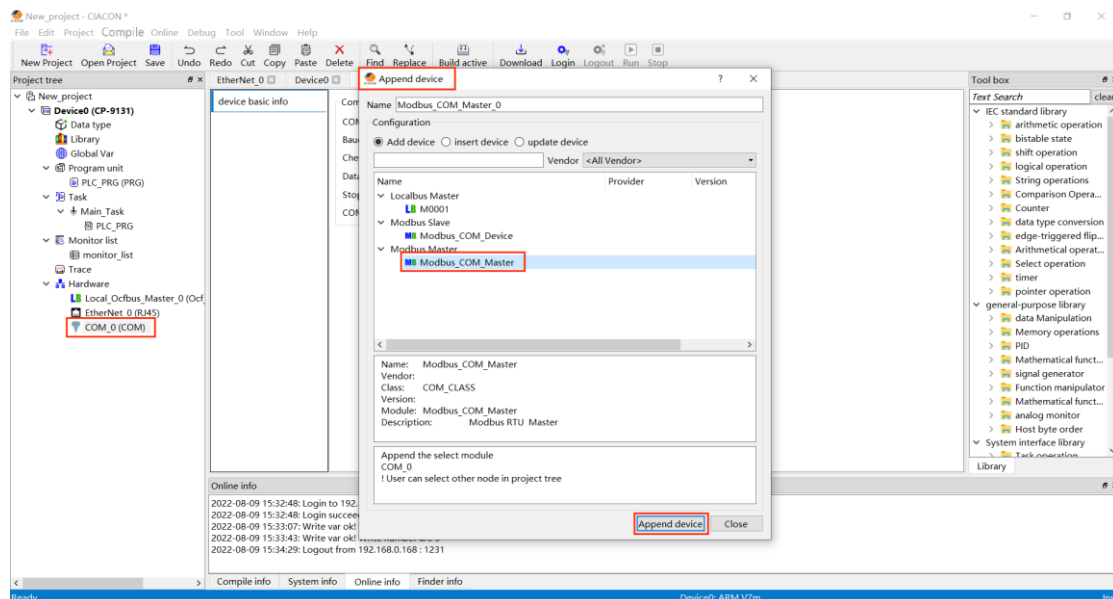

Double-click Modbus_COM_Master and set device basic info. Response timeout: 500ms, Polling TimeOut: 10ms, Transmit mode: RTU.

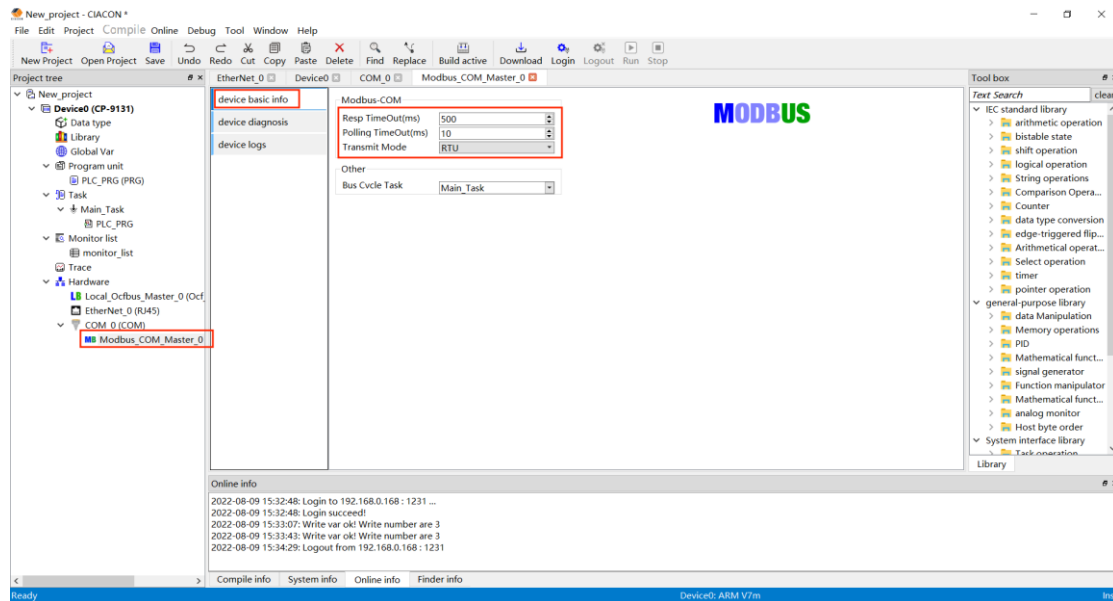

Right-click Modbus_COM_Master and click Add Device. Select Modbus-COM-Slave and click Add Device. If it carries multiple slave devices then it could add multiple Modbus-COM-Slave.

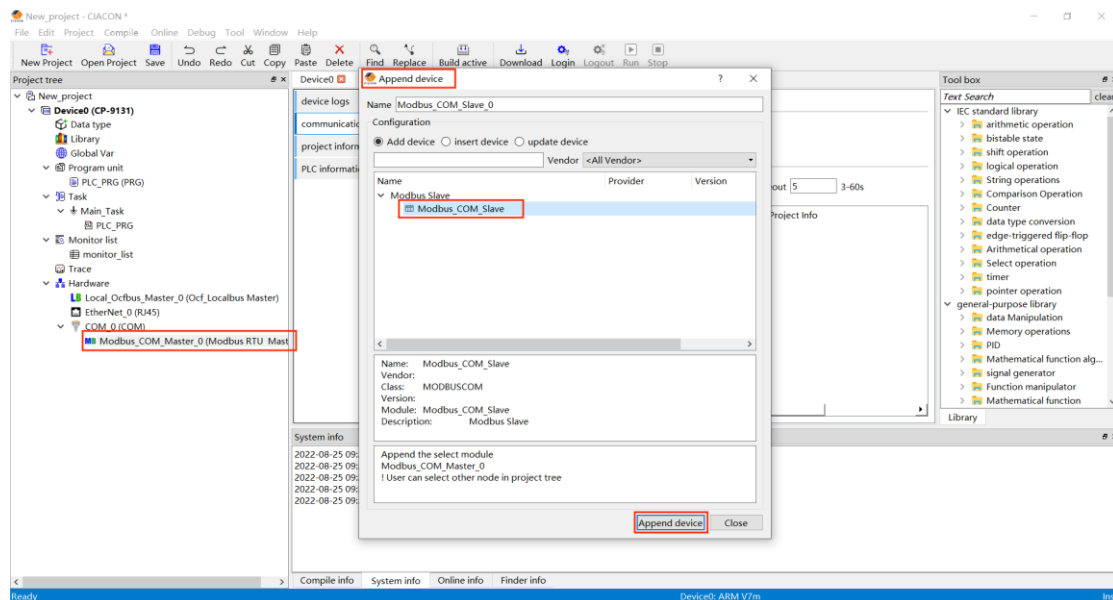

Double-click the Modbus-COM-Slave. In device basic info, it could view the slave address: 1, and set the response timeout time: 500ms.

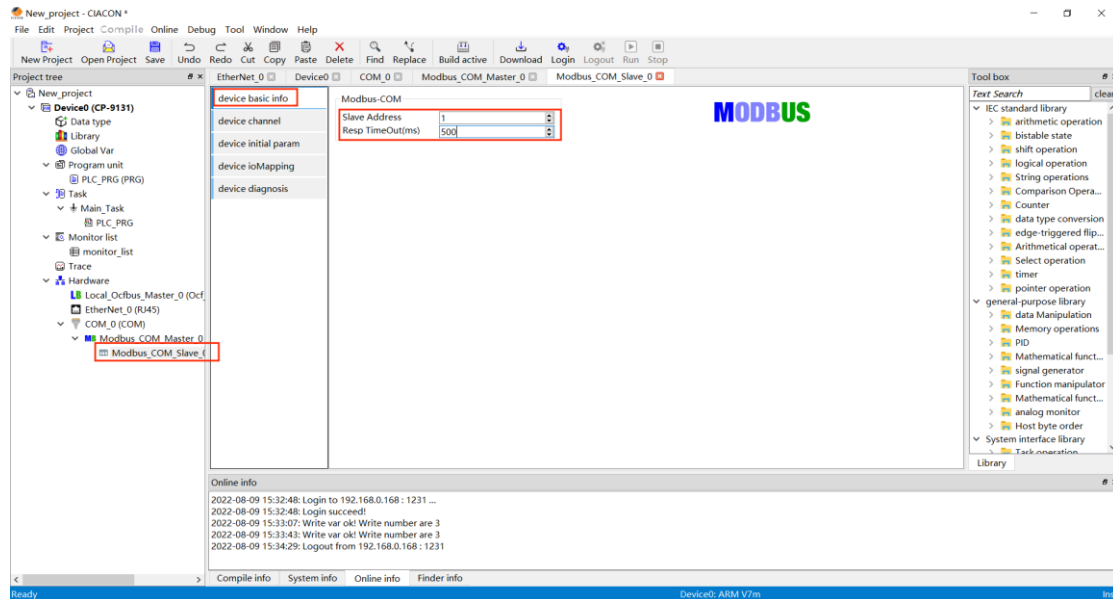

Click device channel, it needs to right-click in the blank area on the right of the interface, and choose Add. It could configure the commands to be delivered in the pop-up window. After clicking OK, a line of commands will be automatically generated, and a corresponding mapping will be automatically generated in the IO mapping configuration.

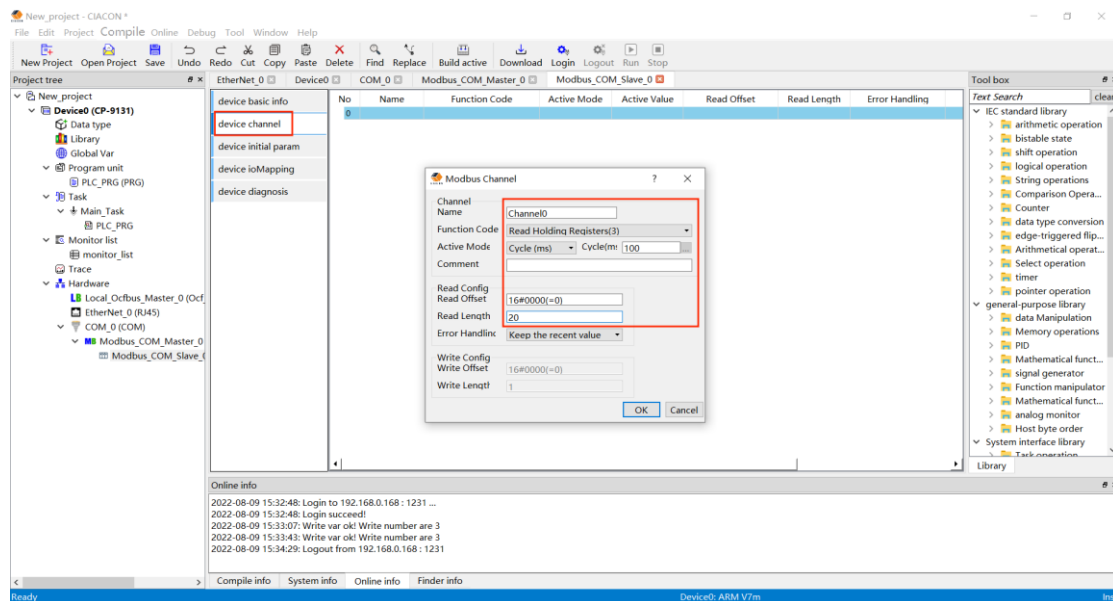

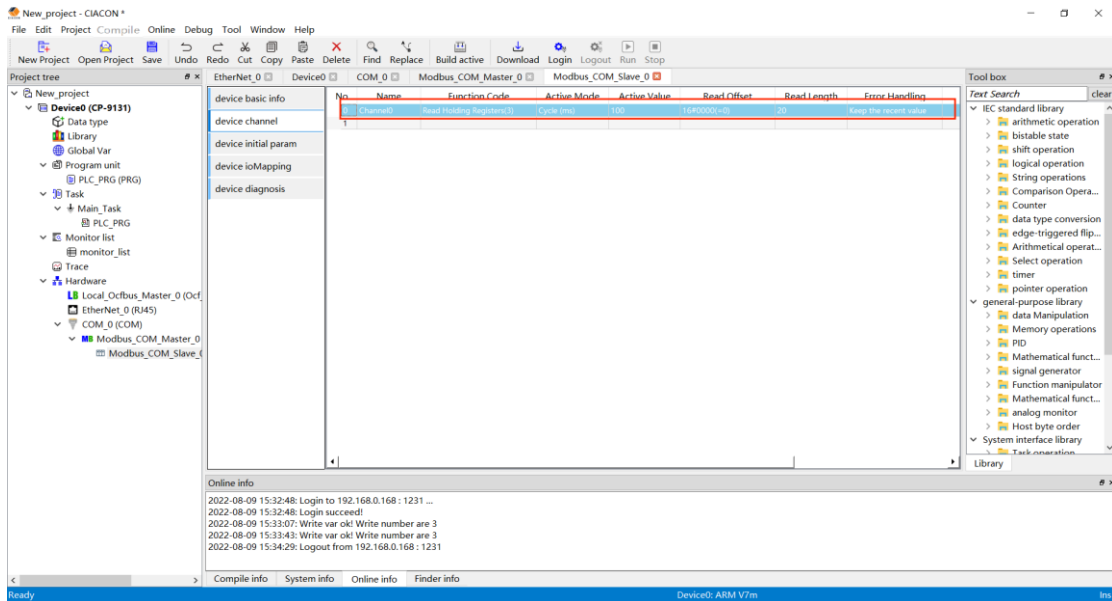

After the communication command configuration is completed, it could select device ioMapping to view the DATA address of the I/O mapping.

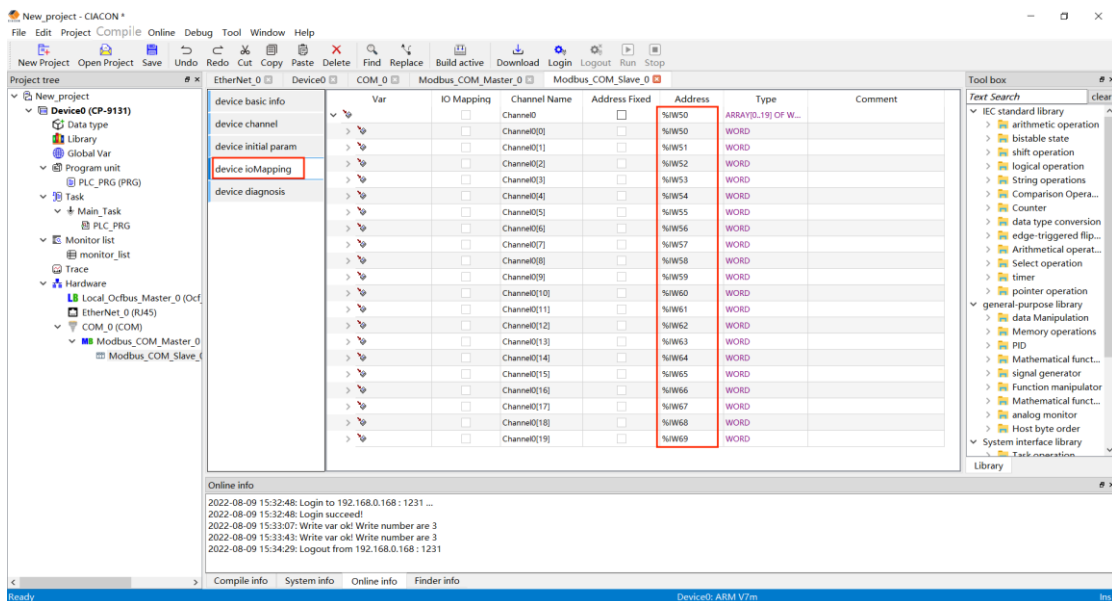

Now the MODBUS RTU master function configuration is completed. It needs to click Compile, re-compile, and confirm: "Clear compile will due to clear the download (clearing the controller), do you want to continue?" Now click OK and it will start compiling. After compiling, please click download.

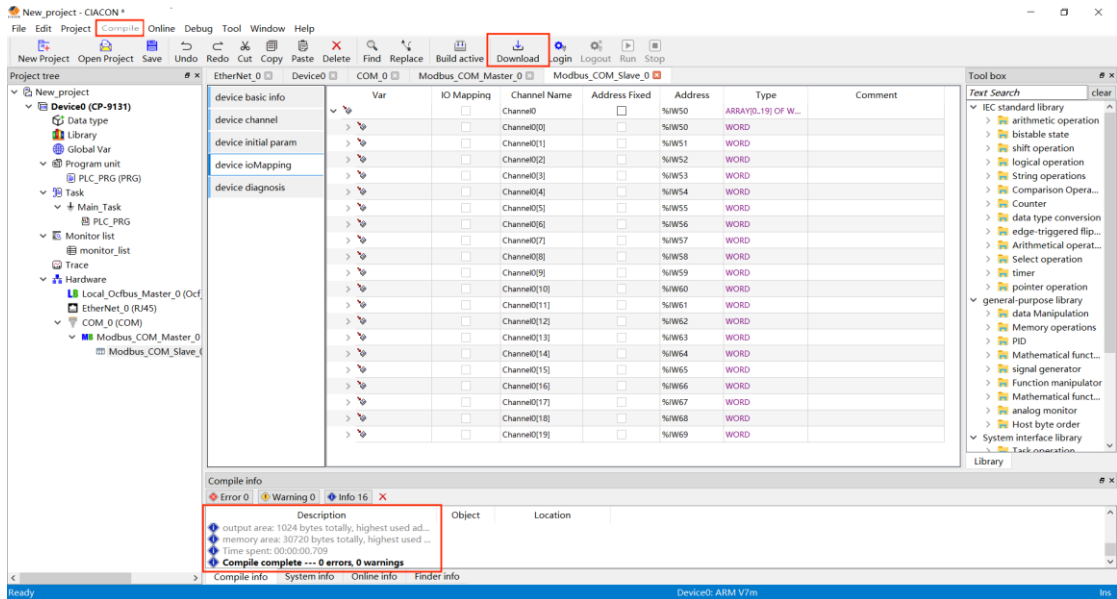

After the download, it could open the Modbus Slave to simulate the RS485 Slave device to test the RS485 function.

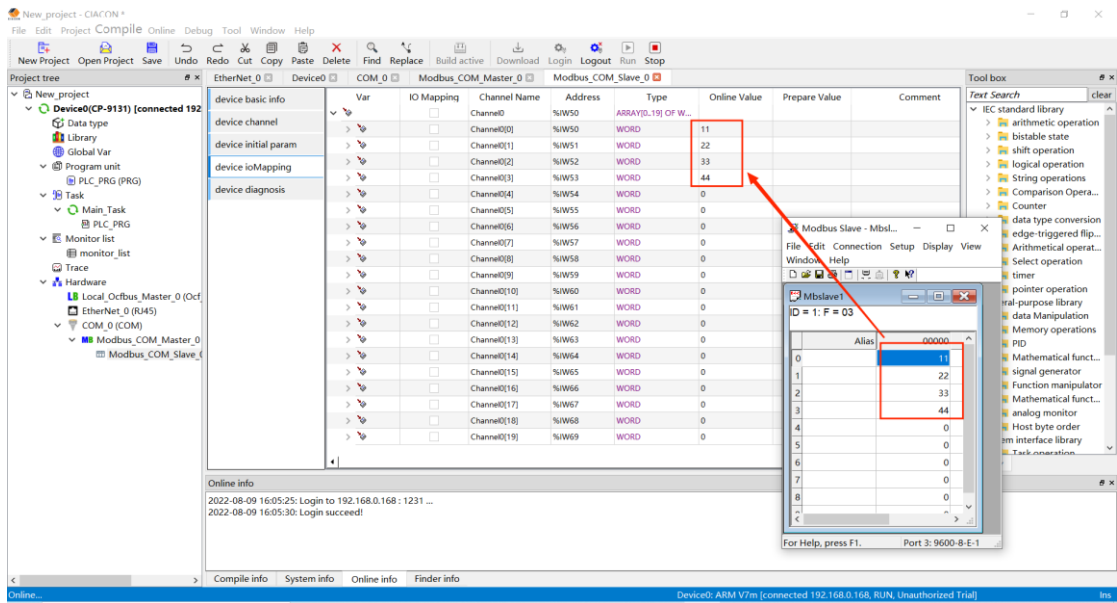

5.8 Modbus RTU Slave Function

Double-click COM_0 to view device basic info. The default values: RS485, 9600bps, E, 8, and 1.

Serial port type: RS485.

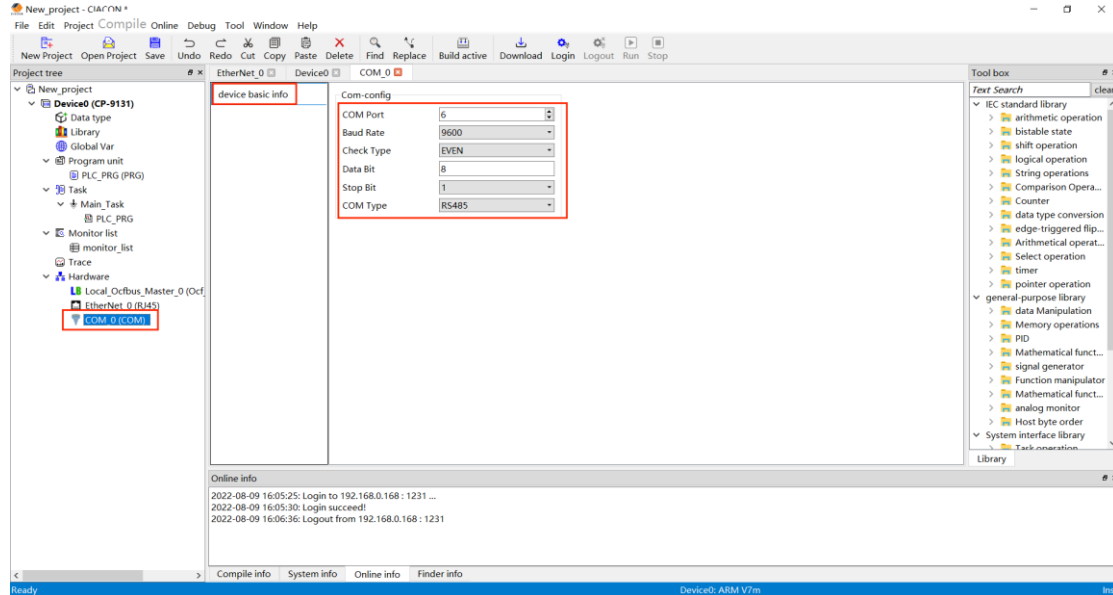

Right-click COM_0 and select Append Module, then it could select Modbus_COM_Device under Modbus master and click Append Device.

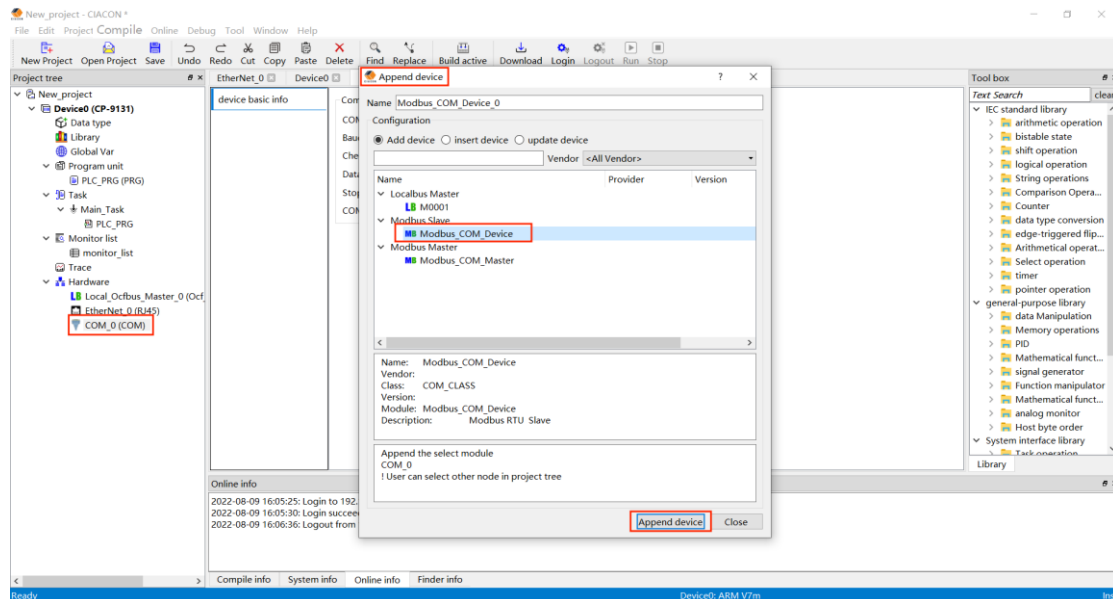

Double-click the newly created Modbus_COM_Device for slave device. And click device basic info to set the response timeout time of the slave : 500ms and slave ID:1.

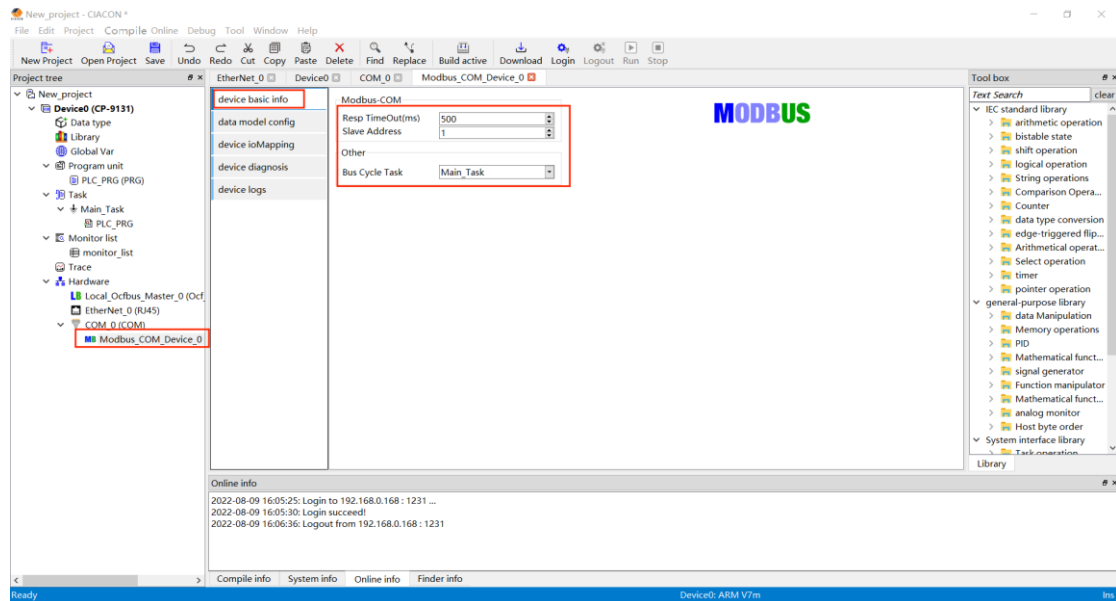

Click Data Model Config to set the mapped Modbus address range.

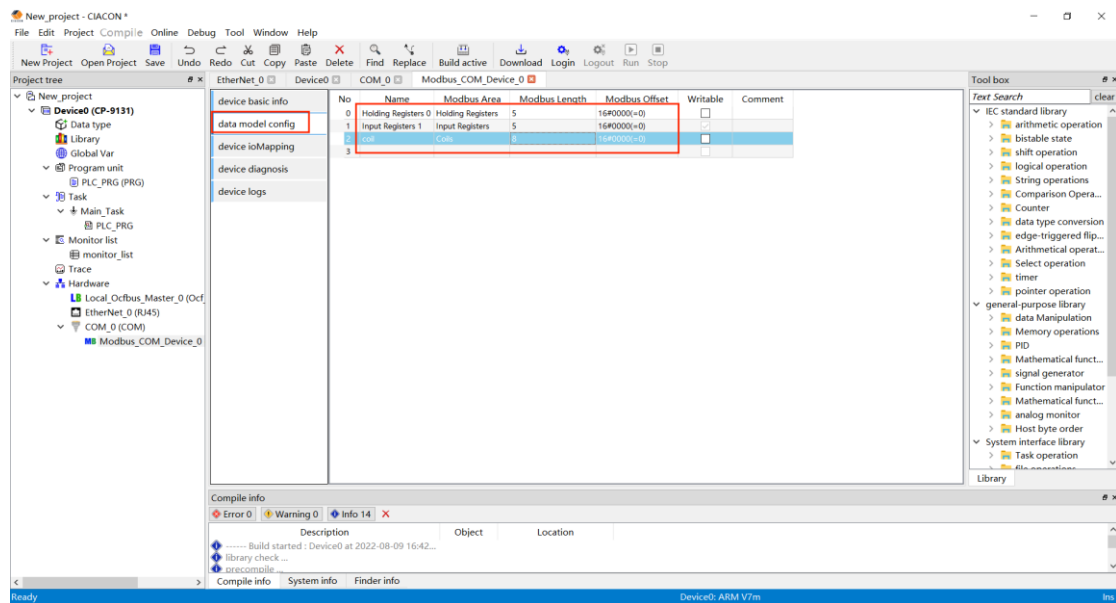

After it is configured, the corresponding PLC internal address mapping will be automatically generated in the device iomapping.

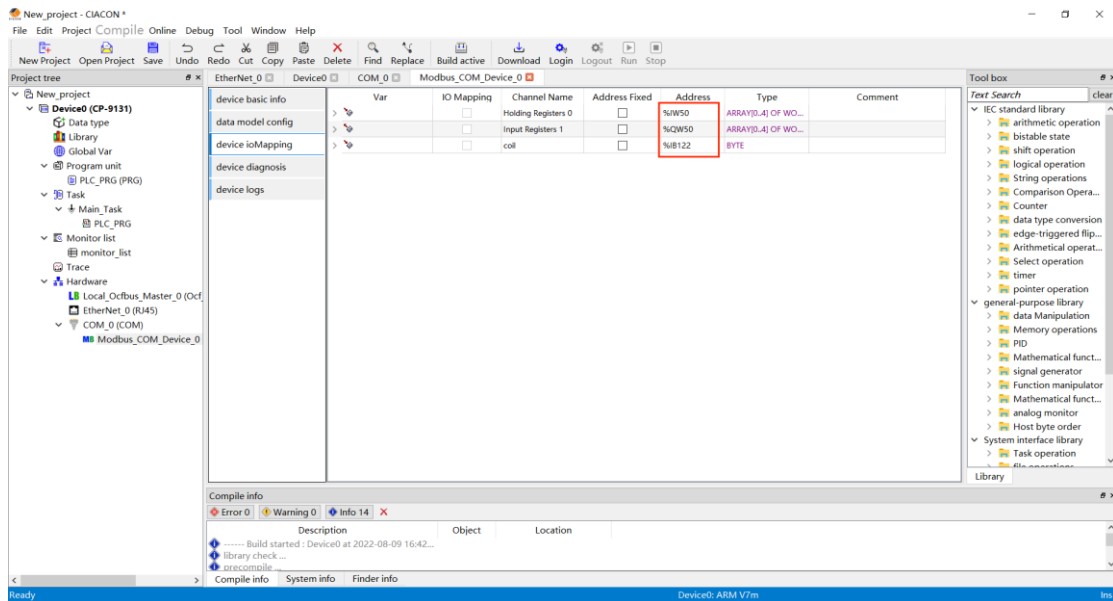

Now the MODBUS RTU slave function configuration is completed. It needs to click Compile, re-compile, and confirm: "Clear compile will due to clear the download (clearing the controller), do you want to continue?" Now click OK and it will start compiling. After compiling, please click download.

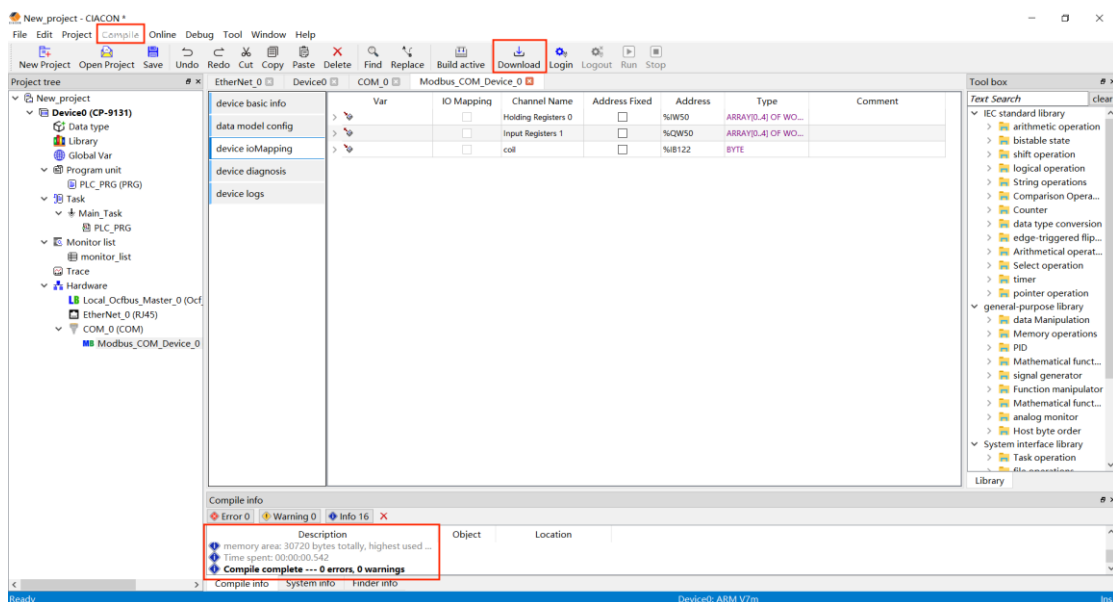

After the download is completed, open the Modbus Poll to simulate RS485 master devices, and it could test this function.

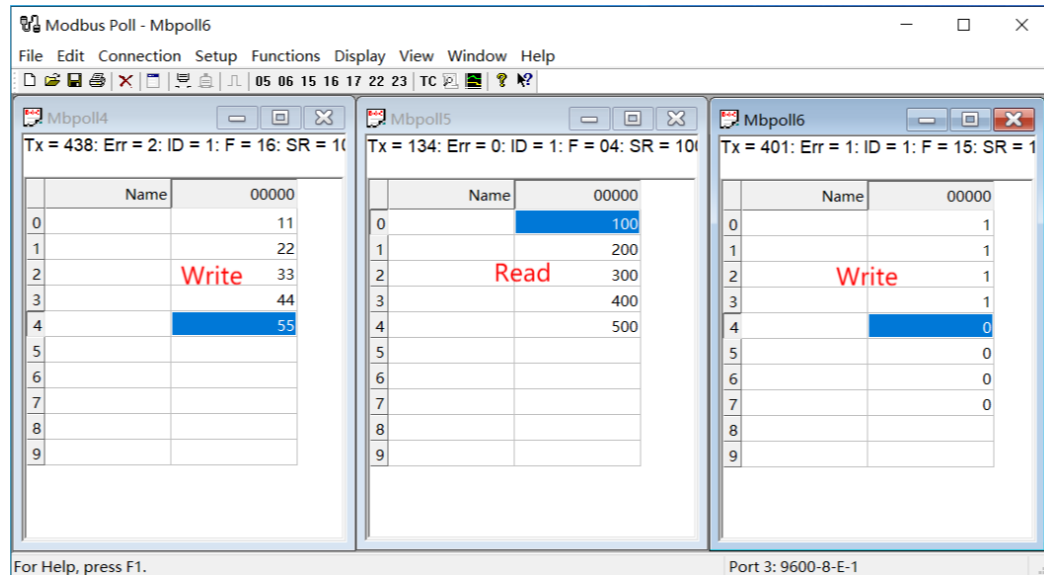
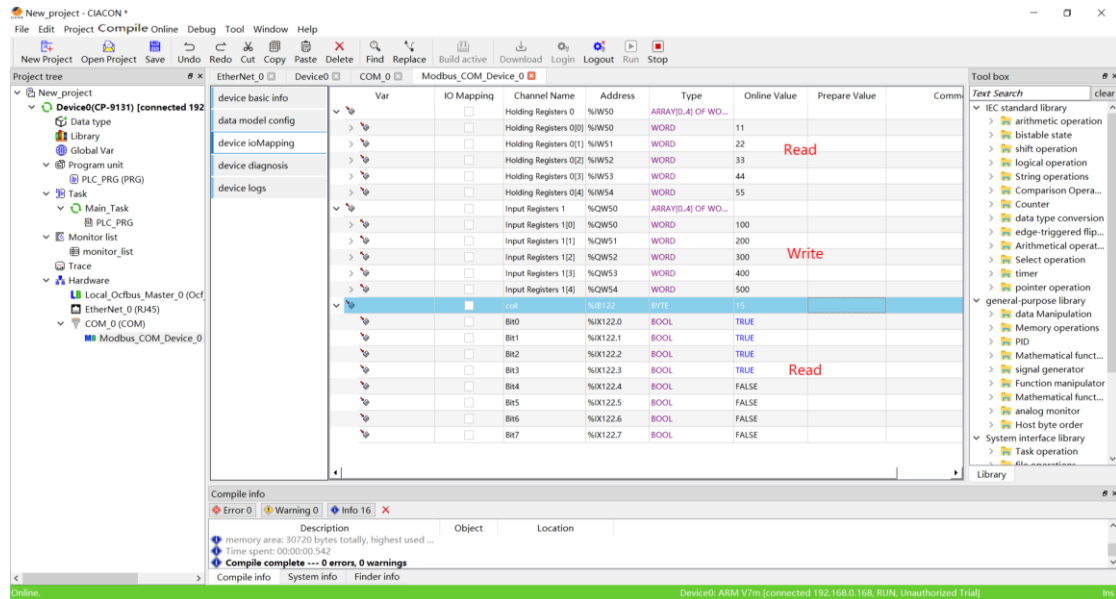

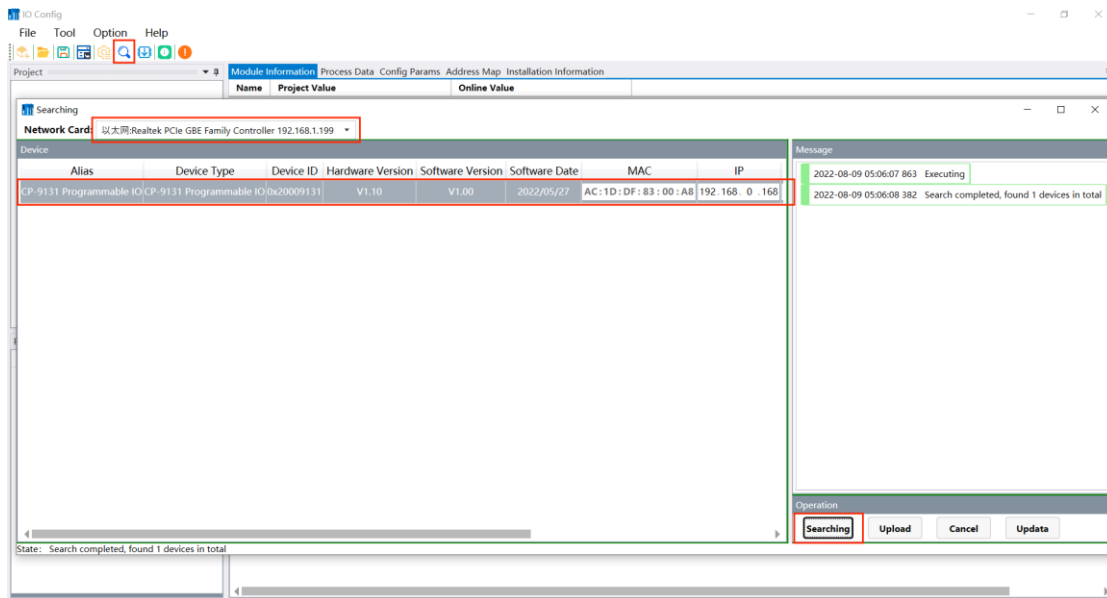

6 Update the firmware

The CP-9131 firmware upgrading will need the IOConfig configuration software. Open the IOConfig configuration software and click the search shortcut key. In the popsup window it could select the local network card and click Search. Then CP-9131 will be displayed in the device list and the IP address of the module could be viewed: 192.168.0.168.

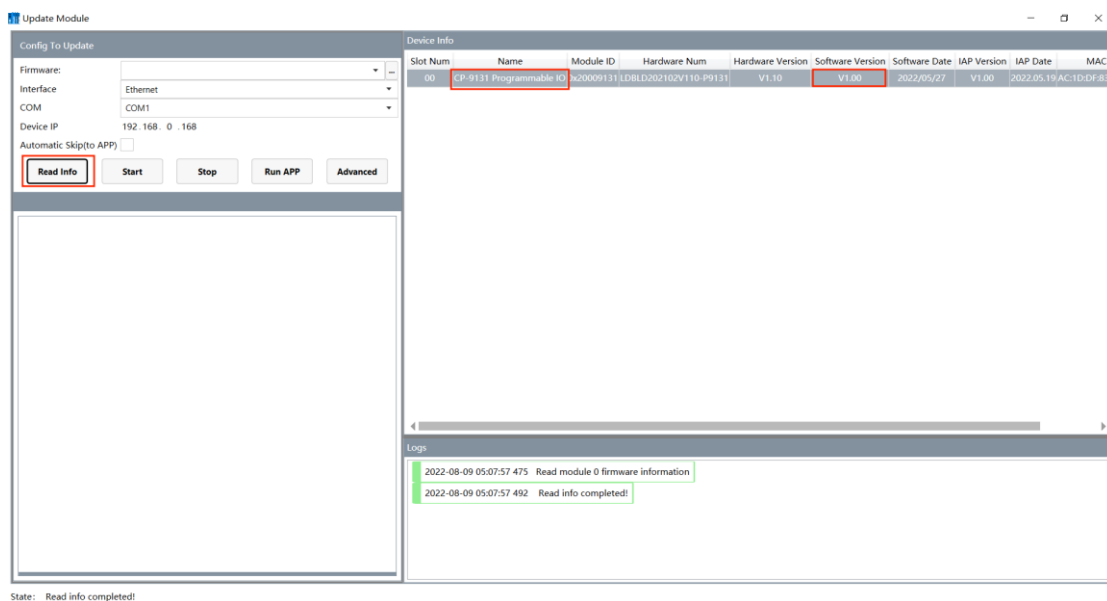

Click the "Upgrade" button at the lower right corner, and click "Read Info" on the interface that pops up to view the version information of the current module.



Click the button on the right of the upgrade file . And in the window that pops up, find the upgrade file and click open.

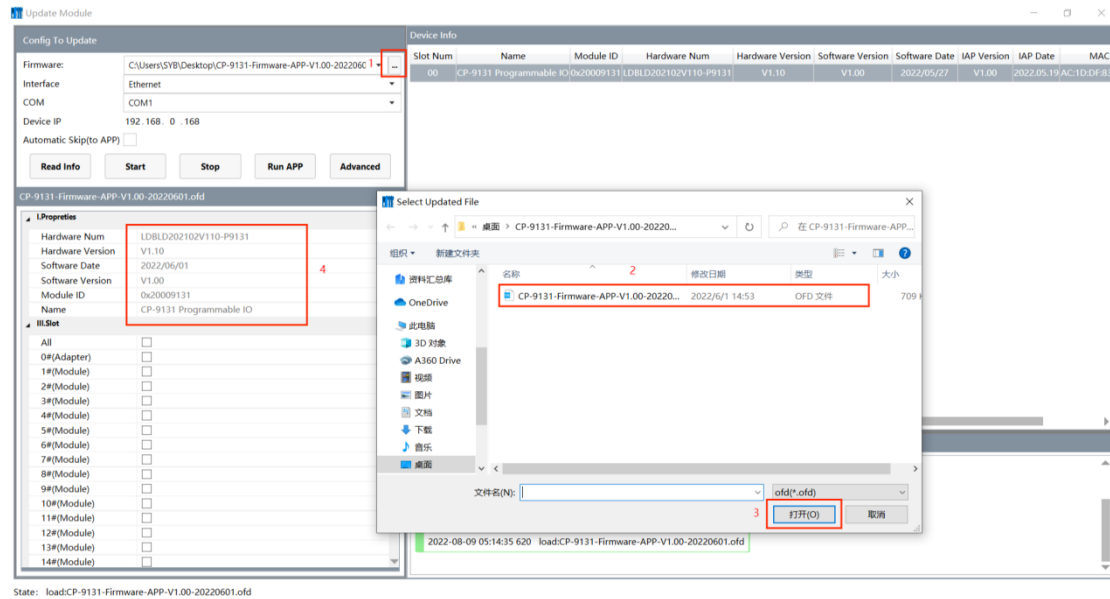

Select 0#(Adapter), tick the box, and click Upgrade. After the upgrading, it needs to click Run APP or power off and restart the module.

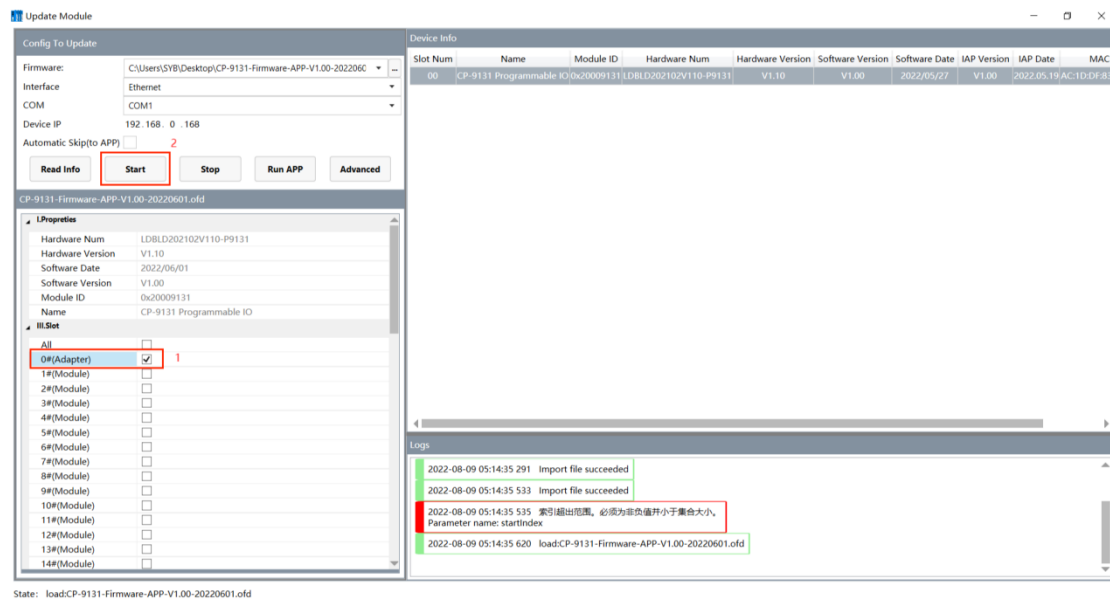

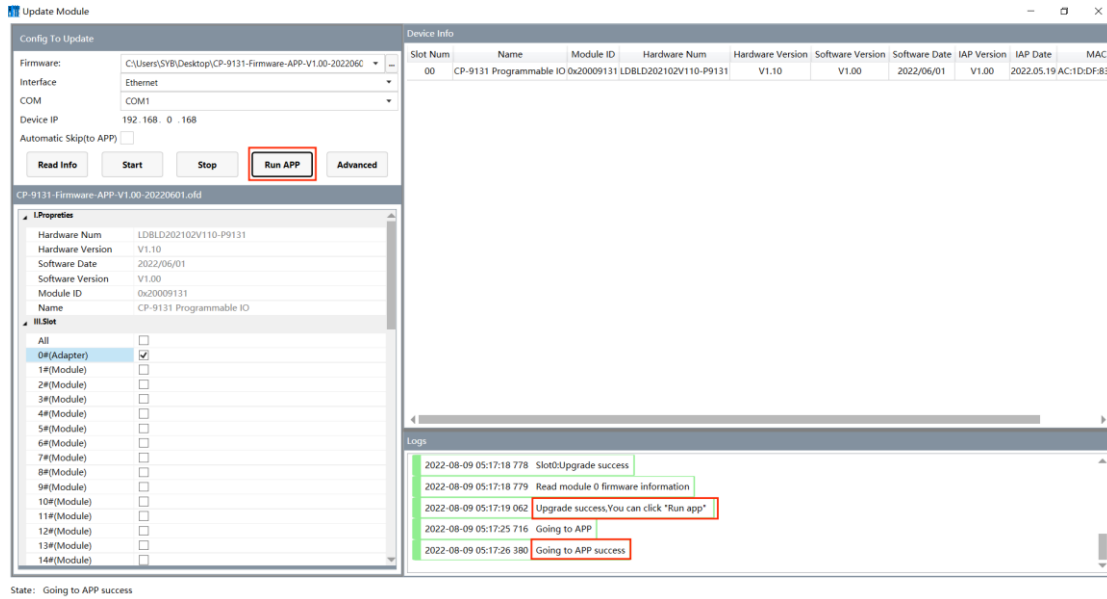

Odot Automation System Co., Ltd.

Add: Plant No. 204 MianYang Comprehensive Bonded Zone, Eastern section of Fei Yun Avenue, MianYang, Sichuan Province, China. 621000

Tel: +86-0816-2538289

Zip Code: 621000

Email: sales@odotautomation.com

Web: www.odotautomation.com

